

KOMATSU®

PC228USLC-8

NET HORSEPOWER

110 kW **148 HP** @ 2000 rpm

OPERATING WEIGHT

24130–24675 kg **53,195–54,405 lb**

BUCKET CAPACITY

0.50–1.20 m³ **0.66–1.57 yd³**

PC
228US
LC



Photo may include optional equipment.

HYDRAULIC EXCAVATOR

WALK-AROUND

Komatsu's PC228USLC-8 Hydraulic Excavators have a short tail swing profile, designed specifically for work in confined areas. By reducing the tail swing, the PC228USLC-8 is perfect for work on roadways, bridges, urban areas, or anywhere space is limited. The PC228USLC-8 provides the performance and productivity you expect from Komatsu equipment.

Ecology and Economy

● ***Low emission engine***

A powerful turbocharged and air-to-air aftercooled Komatsu SAA6D107E-1 engine provides 110 kW **148 HP**(net). This engine is EPA Tier 3 and EU stage 3A emissions certified, without sacrificing power or machine productivity.

● ***Economy mode for lower fuel consumption***

● ***Low operational noise***

The dynamic noise is reduced when compared to the previous model.

Performance Features

● ***Increased lift capacity and stability***

The counterweight mass has increased by 1300 kg **2865 lb** for increased lift capacity over the front and side of the machine.

● ***Improved hydraulic system efficiency***

Enhancements made to the Closed Center Load Sensing system result in faster cycle times and lower fuel consumption.

● ***Wide working range***

● ***Powerful digging forces***

Maintenance Features

● ***Long replacement interval for hydraulic oil and hydraulic filter***

● ***Remote mounted engine oil filter and fuel drain valve***

● ***Standard fuel pre-filter (with water separator)***

● ***Side-by-side cooling concept for improved serviceability***

● ***Equipped with self-diagnostic Equipment Management Monitoring System (EMMS)***



Large TFT LCD Monitor

● ***Easy-to-see 7" large multi-function color monitor panel***

● ***Can be displayed in 12 languages for global support***

TFT: Thin Film Transistor
LCD: Liquid Crystal Display

KOMTRAX®

KOMTRAX equipped machines can send location, SMR and operation maps to a secure website utilizing wireless technology. Machines also relay error codes, cautions, maintenance items, fuel levels, and much more.

Versatility

- **Rounded cab design**
The cab swings within the same swing radius as the counterweight.
- **Short tail swing radius**
More compact than conventional models for improved performance in tight working conditions.

Large Comfortable Cab

- **Low noise cab design with viscous mounts**
- **Sliding convex door - easy entrance in confined areas**
- **Large and comfortable cab space**

Reliability Features

- **High rigidity work equipment**
- **Sturdy frame structure**
- **Reliable Komatsu designed and manufactured components**
- **Highly reliable electronic devices**



Photo may include optional equipment.

General Features

- **Standard rearview monitoring system (1 camera)**
- **Improved attachment flow control**
- **Slip resistant plates for improved grip**
- **New cab design for hydraulic excavators**
- **Operator Protective Guard (OPG) top guard Level 2 capable**

NET HORSEPOWER
110 kW 148 HP @ 2000 rpm

OPERATING WEIGHT
24130 – 24675 kg
53,195 – 54,405 lb

BUCKET CAPACITY
0.50 – 1.20 m³
0.66 – 1.57 yd³

PERFORMANCE FEATURES



Komatsu develops and produces all major components such as engines, electronics and hydraulic components. Combining “Komatsu Technology”, and customer feedback, Komatsu has achieved great advancements in technology. To achieve both high levels of productivity and economical performance, Komatsu has developed the main components with a total control system. The result is a new generation of high performance and environment-friendly excavators.

Low Fuel Consumption

The Komatsu SAA6D107E-1 [ecot3] engine enables NOx emissions to be significantly reduced with the accurate multi-staged fuel injection by the engine controller. It improves total engine durability using the high pressure fuel injection system developed specifically for construction machinery. This excavator significantly reduces hourly fuel consumption using the highly-efficient matching techniques of the engine and hydraulic systems and also provides features that promote energy-saving operations such as Economy mode and the Eco-gauge.

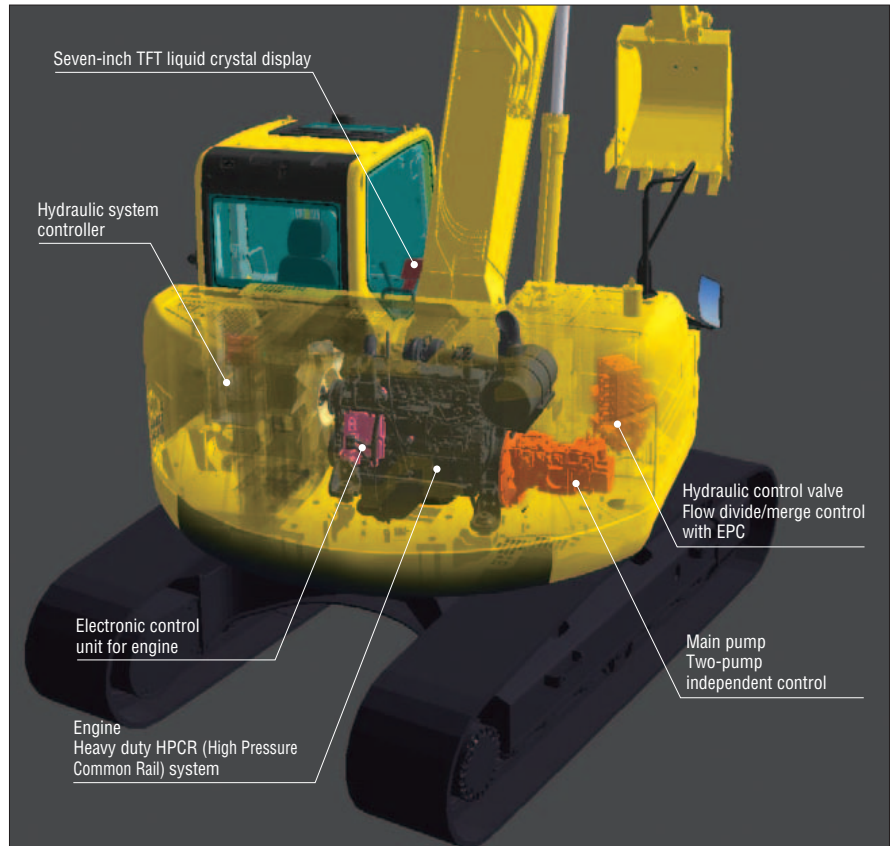

Low Emission Engine

The Komatsu SAA6D107E-1 is EPA Tier 3 and EU stage 3A emissions certified and reduces NOx emission by 29% when compared with the PC228USLC-3.

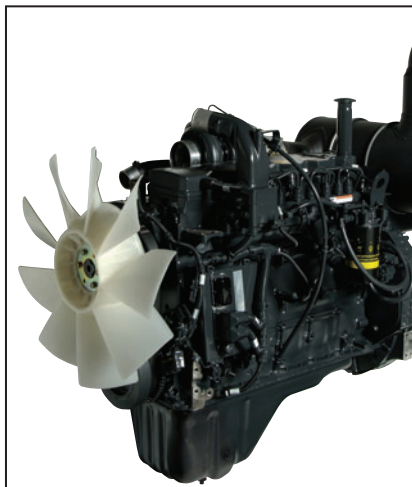

Low Operational Noise

The PC228USLC-8 enables low noise operation using a low-noise engine and methods that reduce noise at the source.

Electronically controlled common rail type engine

- Multi-staged injection
- Highly-rigid cylinder block

Low noise design

- Sound absorbing materials
- Partition between the cab and engine room



Increased Stability and Lift Capacity

The new PC228USLC-8 offers exceptional lift capacity and stability with 1300 kg **2,865 lb** of additional counterweight. With the additional counterweight, the over front lift capacity has increased up to 12%, while over side lift capacity has increased up to 17%.



Wider Working Range

Raising the boom on the PC228USLC-8 to a wider angle enhances overall working performance. Job sites that require a long upper reach, such as demolition and slope cutting, also benefit from the increased digging and dumping ranges of the PC228USLC-8 over the conventional PC200LC-8.

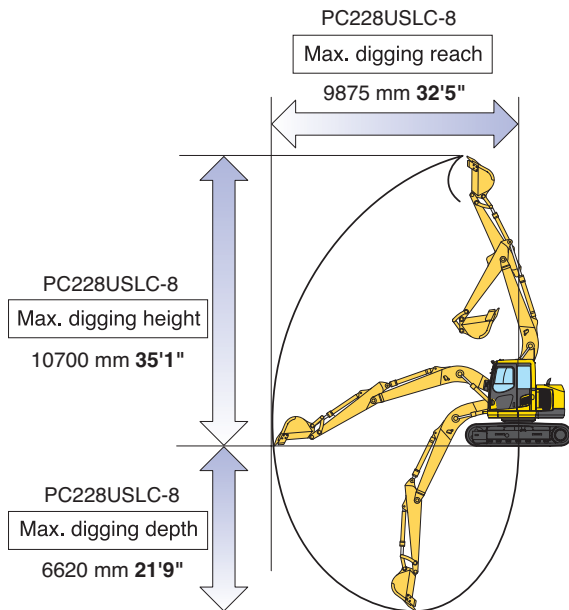

	PC228USLC-8	PC200LC-8
Max Digging Height	10700 mm 35'1"	10000 mm 32'10"
Max Digging Depth	6620 mm 21'9"	6620 mm 21'9"
Max Dumping Height	7825 mm 25'8"	7110 mm 23'4"

Hydraulic System Efficiency

The PC228USLC-8 uses a Closed-center Load Sensing (CLSS) hydraulic system that maximizes fuel efficiency and provides quick responsiveness to the operator's demand.

Using high efficiency matching techniques between the engine and the hydraulic system, the PC228USLC-8 also features Variable Speed Matching. Variable Speed Matching gives the operator power on demand when it's needed, resulting in higher efficiency and lower fuel consumption.

The PC228USLC-8 has reduced hydraulic loss by means of increased piping size in the bucket circuit and a quick return valve to improve overall efficiency.

Large Digging Force

The digging force of the PC228USLC-8 is equal to that of the PC200LC-8. With the Power Max function, the operator can increase the digging force by 8% when extra power is required (8.5 seconds of operation).

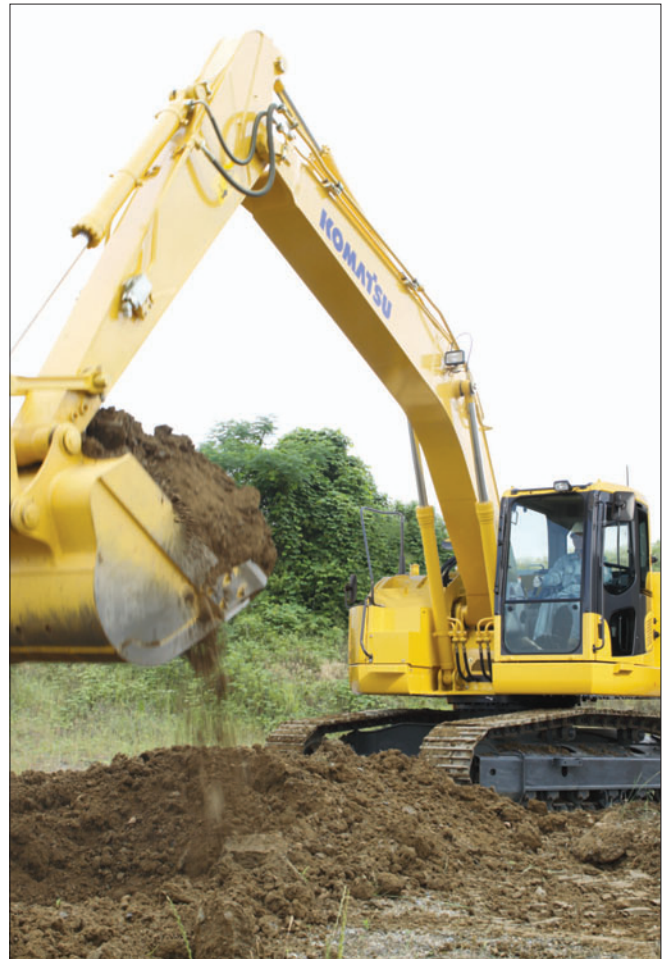

Photo may include optional equipment.

VERSATILITY

Short Implement Swing Radius

2310 mm 7'7" — Boom raising angle of the PC228USLC-8 is larger than the PC200LC-8.

Contoured Cab Design

The short tail swing design uses a round profile for the corners on the front and rear sides of the machine. The round profile design allows the cab and counterweight to swing in the same turning radius, enhancing the performance of the machine in tight working conditions.

Minimum implement swing radius
2310 mm 7'7"

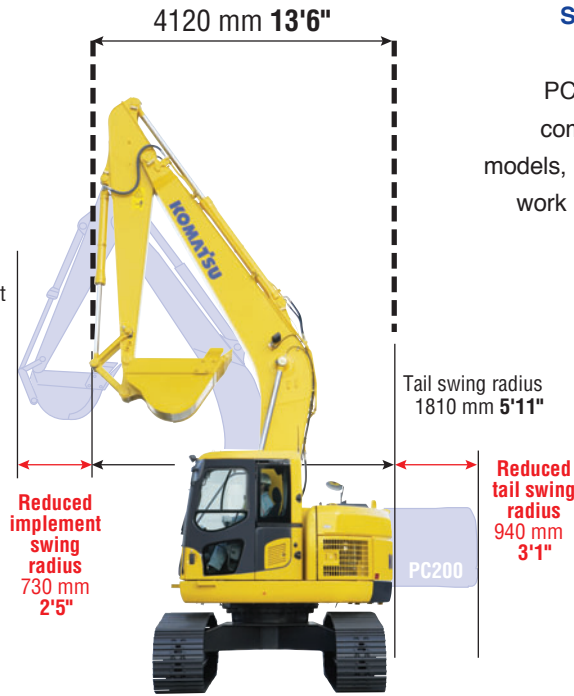

Short tail swing radius:

1810 mm 5'11" — The PC228USLC-8 tail is more compact than conventional models, allowing the machine to work in more confined areas.

Road and Bridge Work

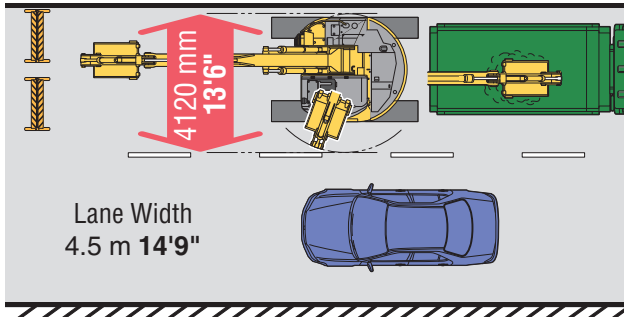

Logging Road Work

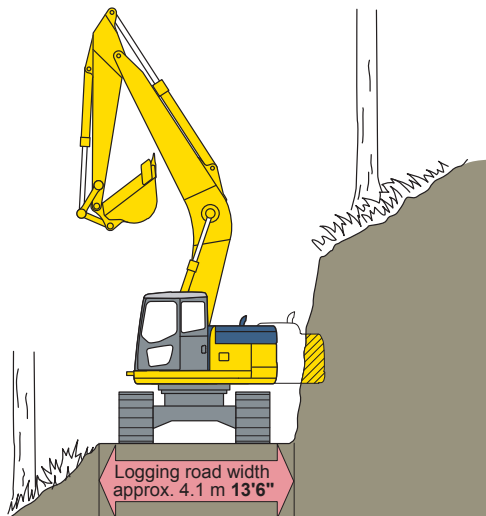

RELIABILITY FEATURES

High Rigidity Work Equipment

Booms and arms are constructed with thick plates of high tensile strength steel. In addition, these structures are designed with large cross-sectional areas and generous use of castings. The result is working attachments that exhibit long term durability and high resistance to bending and torsional stress.

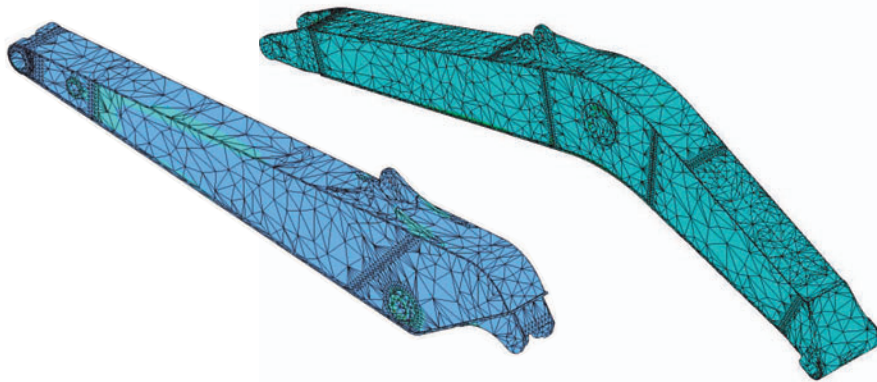

Sturdy Frame Structure

The revolving frame, center frame and undercarriage are designed by using the most advanced three-dimensional CAD and FEM analysis technology.

Highly Reliable Electronic Devices

Exclusively designed electronic devices have passed severe testing.

- Controller
- Sensors
- Connectors
- Heat resistant wiring

Metal Guard Rings Protect all the Hydraulic Cylinders and Improve Reliability

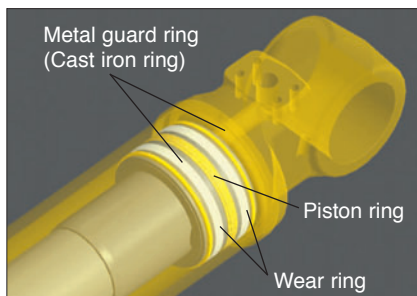

Reliable Components

All of the major machine components, such as engine, hydraulic pumps, hydraulic motors and control valves are Komatsu designed.

Durable Arm Tip Bushing

The end face of the arm tip bushing provides high resistance to seizure and wear.

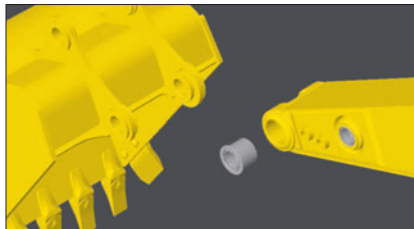

DT-type Connectors

Sealed DT-type connectors provide high reliability, water resistance, and dust resistance.

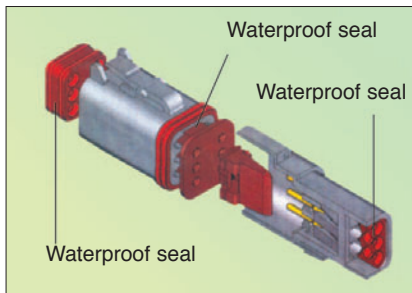

Grease Sealed Track

PC228USLC-8 uses grease sealed tracks for extended undercarriage life.

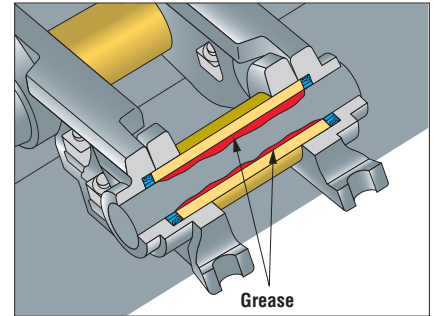

Track Link with Strut

The PC228USLC-8 track links have a strut, providing superb durability.

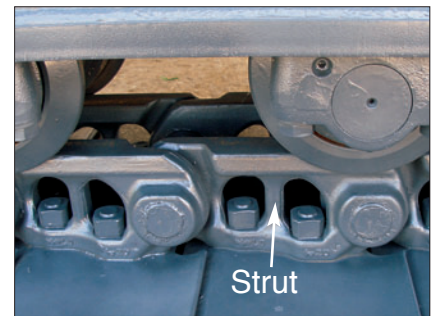

O-ring Face Seal

Flat face-to-face O-ring seals are used to securely seal hydraulic hose connections.

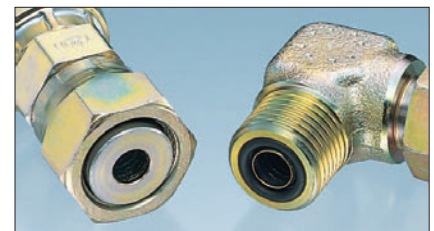

WORKING ENVIRONMENT

The PC228USLC-8 cab interior is spacious and provides a comfortable working environment...

Large Comfortable Cab

Multi-position Controls

The multi-position, Pressure Proportional Control (PPC) levers allow the operator to work in comfort while maintaining precise control.

A double-slide mechanism allows the seat and controllers to move together or independently, allowing the operator to position the seat and controllers for maximum productivity and comfort.

Low Cab Noise

The newly-designed cab is highly rigid and has excellent sound absorption ability. Improvement of noise source reduction and use of low noise engine, hydraulic equipment, and air conditioner allow this machine to generate a low level of noise similar to that of a modern automobile.

Comfortable Ride with Viscous Cab Mounts

Viscous mounts are used for the cab mount system. The cab mount system absorbs shocks and reduces vibration to provide a comfortable ride.

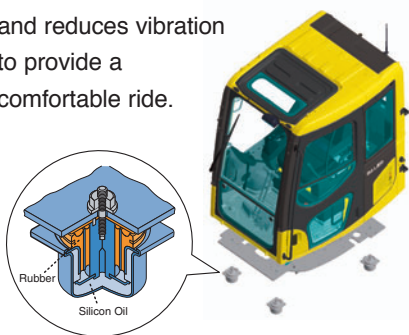

Pressurized Cab

Automatic air conditioner, air filter, and a higher internal air pressure minimize the amount of external dust that enters the cab.



Wide Newly-designed Cab

Large cab provides ample operation space and includes a high-back seat. The cab has a wide doorway for easy access.



Automatic Air Conditioner

Enables you to easily and precisely set cab atmosphere with the instruments on the large LCD.

The bi-level control function keeps the inside of the cab comfortable from top to bottom throughout the year. Defroster function keeps cab glass clear.



Sliding Convex Door

The sliding convex door facilitates easy entrance in confined areas.



Features

New Cab Design for Hydraulic Excavators

The cab is designed specifically for hydraulic excavators and gains reinforced strength from the pipe-structured cab framework. The cab framework provides the high durability and impact resistance with very high impact absorbency.



Skylight

Skylight can be opened for additional overhead visibility.



Travel Alarm

An alarm is installed as standard equipment to give other workers a warning when the machine travels in forward or reverse.

Slip Resistant Plates

Durable slip resistant plates maintain excellent foot traction.



Lock Lever

When the lock lever is placed in lock position all hydraulic controls (travel, swing, boom, arm and bucket) are inoperable.



Lever shown in lock position

Work Area Rearview Camera System

The operator can view directly behind the machine through the color monitor panel.



Monitor for rearview camera

Wide Visibility

The right side window pillar has been removed and the rear pillar reshaped to provide improved visibility.



Large TFT LCD Monitor

Large Multi-Lingual LCD Monitor

A large user-friendly color monitor enables accurate and smooth work. Screen visibility is improved by using a TFT liquid crystal display that can easily be read at various angles and lighting conditions. All switches are simple and easy to operate. Industry-first function keys facilitate multi-function operations. Data can be displayed in 12 languages to globally support operators around the world.

Indicators

- | | |
|----------------------------------|-----------------------------------|
| 1 Auto-decelerator | 5 Hydraulic oil temperature gauge |
| 2 Working mode | 6 Fuel gauge |
| 3 Travel speed | 7 Eco-gauge |
| 4 Engine water temperature gauge | 8 Function switches menu |

Basic operation switches

- | | |
|-------------------------|---------------------|
| 1 Auto-decelerator | 4 Buzzer cancel |
| 2 Working mode selector | 5 Wiper |
| 3 Travel speed selector | 6 Windshield washer |

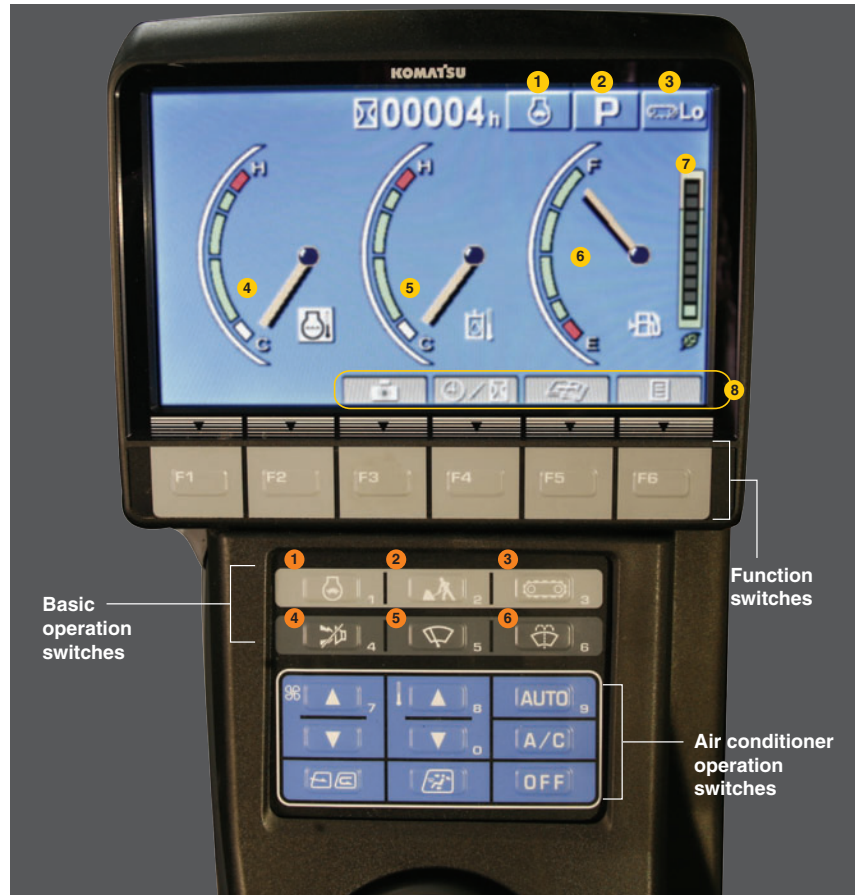

Working Mode Selection

The PC228USLC-8 excavator is equipped with five working modes (P, E, L, B, and ATT). Each mode is designed to match engine speed, pump flow, and system pressure with the current application. This provides the flexibility to match equipment performance to the job at hand.

Working Mode	Application	Advantage
P	Power mode	<ul style="list-style-type: none"> Maximum production/power Fast cycle times
E	Economy mode	<ul style="list-style-type: none"> Excellent fuel economy
L	Lifting mode	<ul style="list-style-type: none"> Hydraulic pressure is increased by 7%
B	Breaker mode	<ul style="list-style-type: none"> Optimum engine rpm, hydraulic flow, 1-way
ATT	Attachment mode	<ul style="list-style-type: none"> Optimum engine rpm, hydraulic flow, 2-way

Lifting Mode

When the lifting mode is selected, lifting capacity is increased 7% by raising hydraulic pressure.

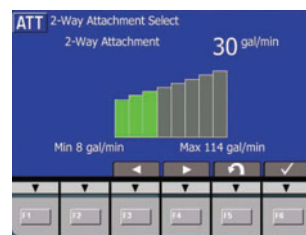

Improved attachment flow control

Flow rates can easily be adjusted for one-way and two-way flow attachments through the monitor.

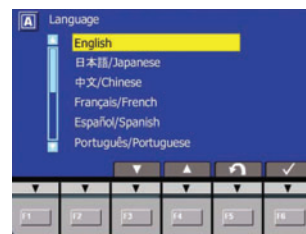

Multiple languages

The monitor can be displayed in 12 languages

MAINTENANCE FEATURES

Easy Maintenance

Komatsu designed the PC228USLC-8 to have easy service access. By doing so, routine maintenance and servicing are less likely to be skipped, which can mean a reduction in costly downtime later on. Here are some of the many service features found on the PC228USLC-8.

Optimum Maintenance Layout

With the left and right side service doors, it is possible to access the major maintenance points from ground level. Furthermore, the fuel drain valve, engine oil filter, swing machinery oil filler, and PTO oil filler are remote mounted, facilitating easy maintenance.

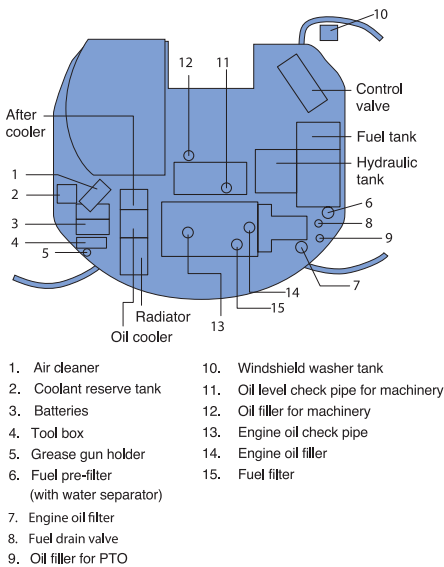

Equipped with the Fuel Pre-filter (with Water Separator)

Removes water and contaminants in the fuel to help prevent fuel problems (with built in priming pump).



Side-by-side Cooling

Since the oil cooler, aftercooler and radiator are arranged side-by-side, it is easy to clean, remove, and install them.



Maintenance Costs Reduced

Eco-white Filter Element

High performance filters are used in the hydraulic circuit and engine. Longer replacement intervals for the hydraulic oil, hydraulic oil filter, engine oil and engine oil filter element significantly reduce maintenance costs.

- Engine oil & Engine oil filter** every **500** hours
- Hydraulic oil** every **5000** hours
- Hydraulic oil filter** every **1000** hours



Longer Greasing Intervals

Special hard material is used for the work equipment bushings to lengthen greasing intervals. All work equipment bushing lubrication intervals, except arm tip and bucket linkage, are 500 hours, reducing maintenance costs.

Self-Diagnostic Monitor

The PC228USLC-8 features the most advanced diagnostics system in the industry. The Komatsu-exclusive system identifies maintenance items, reduces diagnostic times, indicates oil and filter replacement hours, and displays error codes.

Continuous Machine Monitoring System

When the starting switch is turned ON, check-before-starting items and caution items appear on the LCD. If abnormalities are found, a warning lamp blinks and a warning buzzer sounds. Continuous machine condition checks help prevent the development of serious problems and allow the operator to concentrate on the work at hand.

Abnormalities Display with Code

When an abnormality occurs during operation, a user code is displayed. When an important user code is displayed, a caution lamp blinks and a warning buzzer sounds to alert the operator to take action.

Oil Maintenance Function

When the machine exceeds the oil or filter replacement time, the oil maintenance monitor will display lights to inform the operator.

Trouble Data Memory Function

The monitor stores abnormality data for effective troubleshooting.



Normal display

Maintenance List	Interval	Remain
Engine Oil Change	500 h	480 h
Eng Oil Filter Change	500 h	480 h
Fuel Main Filter Change	1000 h	980 h
Fuel Pre Filter Change	500 h	480 h
Hyd Oil Filter Change	1000 h	980 h
H/Tank Breather Change	500 h	480 h

Maintenance time display

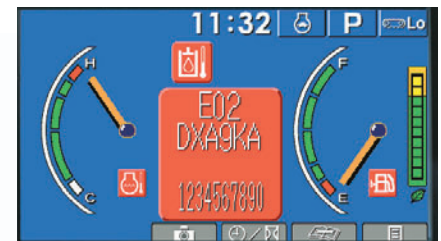

Error code display



Photo may include optional equipment.

KOMTRAX® EQUIPMENT MONITORING



KOMTRAX is Komatsu's remote equipment monitoring and management system. KOMTRAX gathers critical machine and operation information and provides it in a user-friendly format so that you can make well-informed decisions. KOMTRAX gives you more control of your equipment and better control of your business!

KOMTRAX comes standard on all new Komatsu excavators with free communications services for the first five years of ownership. It is a powerful tool and makes Komatsu excavators an even better purchase!

Fleet Optimization

KOMTRAX tells you how your machines and operators are performing. KOMTRAX provides:

- Fuel consumption data and trends, by unit or fleet
- Machine fuel level
- Machine utilization
- Actual working hours/Machine idle hours
- Attachment usage hours
- Machine travel hours
- Machine load analysis
- Operating mode ratios

Location and Asset Management

KOMTRAX tells you where your machines are and can help prevent unauthorized use. KOMTRAX provides:

- GPS location/Operation maps
- Out-of-area and movement alert w/location and time
- Engine, nighttime, and calendar lock

Maintenance Management

KOMTRAX monitors the health of your machines and provides critical information so that you, and your distributor, can take proactive maintenance measures and reduce downtime. KOMTRAX provides:

- Service Meter Reading (SMR)
- Cautions/Abnormality codes
- Maintenance replacement notifications

Easy and Flexible Access to Information

With KOMTRAX, information about your machines is available anytime, anywhere. KOMTRAX provides:

- A user-friendly KOMTRAX website that provides customized access to your machine information
- E-mail and text alerts
- Web dial-up service
- Monthly fleet summary reports

For more information, ask your distributor, pick up a KOMTRAX brochure, or go to www.komatsuamerica.com/komtrax.



PARTS & SERVICE SUPPORT



Komatsu builds the most reliable and technologically-advanced excavators in the industry. Komatsu, and your Komatsu distributor, can provide comprehensive parts and service support during the entire life-cycle of your machine.

The Parts You Need . . . When You Need Them!

Because downtime can be costly, Komatsu makes sure that the parts you need are ready when you need them; with the same Komatsu quality and fit as the original.



To provide superior support, your local Komatsu distributor maintains an extensive supply of genuine Komatsu parts. If the part is not in stock, our integrated distributor/OEM parts network, which consists of a

Master Parts Distribution Center, located in Ripley, TN and eight regional Parts Depots, can get you any part within 24 hours. Internet parts ordering, using **e-partscentral**, allows quick and easy product purchases.

Komatsu Remanufactured Products — complete engines, transmissions, torque converters and even circuit boards — offer like-new performance, same-as-new warranties, at a significant cost reduction.

Worry-Free Ownership

At Komatsu, we work hard to help you successfully manage the complete life-cycle of your machines. Key components in achieving this goal are Komatsu Customer Support Programs (CSP's). CSP's can be customized to fit your

business plan, schedule, and budget. They let you enjoy worry-free ownership and let you get back to the job you do best — running your business.

Komatsu Oil & Wear Analysis (KOWA) assists in monitoring your machine's condition and scheduling repairs. Our new *Track Management System (TMS)* allows you to optimize the life of your undercarriage by reducing costs and extending its life.



Other CSP's address routine service requirements. From *Planned Maintenance (PM-Pro)* to *Repair & Maintenance (R&M)* contracts, Komatsu has you covered. While Komatsu's standard warranty covers your machine for 1 year with unlimited hours, our *Advantage Extended Coverage* will also add value to your investment and give you the peace of mind that unexpected repairs are covered.

By partnering with Komatsu and your local Komatsu distributor, you will get the most out of your Komatsu excavator; optimize production, minimize expense, maximize resale value, and enjoy worry-free ownership.



SPECIFICATIONS



ENGINE

Model Komatsu SAA6D107E-1*
 Type Water-cooled, 4-cycle, direct injection
 Aspiration Turbocharged and air-to-air aftercooled
 Number of cylinders 6
 Bore 107 mm **4.21"**
 Stroke 124 mm **4.88"**
 Piston displacement 6.69 ltr **408 in³**
 Power rating
 Gross (SAEJ1995) 116 kW **155 HP** @ 2000 rpm
 Net (ISO 9249/SAEJ1349) 110 kW **148 HP** @ 2000 rpm
 Fan drive type Mechanical
 Governor All-speed control, electronic

*EPA Tier 3 and EU Stage 3A emissions certified.



HYDRAULIC SYSTEM

Type HydrauMind (Hydraulic Mechanical Intelligence New Design) system, closed-center system with load sensing valves and pressure compensated valves
 Number of selectable working modes 5
 Main pump:
 Type Variable displacement piston type
 Pumps for Boom, arm, bucket, swing, and travel circuits
 Maximum flow 439 ltr/min **116 U.S. gal/min**
 Supply for control circuit Self-reducing valve
 Hydraulic motors:
 Travel 2 x axial piston motor with parking brake
 Swing 1 x axial piston motor with swing holding brake
 Relief valve setting:
 Implement circuits 37.3 MPa 380 kgf/cm² **5,400 psi**
 Travel circuit 37.3 MPa 380 kgf/cm² **5,400 psi**
 Swing circuit 28.4 MPa 290 kgf/cm² **4,120 psi**
 Pilot circuit 3.2 MPa 33 kgf/cm² **470 psi**
 Hydraulic cylinders:
 (Number of cylinders – bore x stroke x rod diameter)
 Boom 2–120 mm x 1385 mm x 85 mm **4.7" x 54.5" x 3.3"**
 Arm 1–135 mm x 1490 mm x 95 mm **5.3" x 58.7" x 3.7"**
 Bucket 1–115 mm x 1120 mm x 80 mm **4.5" x 44.1" x 3.2"**



SWING SYSTEM

Drive method Hydrostatic
 Swing reduction Planetary gear type, double reduction
 Swing circle lubrication Grease-bathed
 Swing lock Mechanical disc brake
 Swing speed 11.0 rpm
 Swing torque 6656 kg·m **48,124 ft lbs**



DRIVES AND BRAKES

Steering control Two levers with pedals
 Drive method Hydrostatic
 Maximum drawbar pull 202 kN 20600 kgf **45,410 lb**
 Travel motor Axial piston motor, in-shoe design
 Reduction system Planetary gear type, double reduction
 Gradeability 70%, 35°
 Maximum travel speed: High 5.5 km/h **3.4 mph**
 Mid 4.1 km/h **2.5 mph**
 Low 3.0 km/h **1.9 mph**
 Service brake Hydraulic lock
 Parking brake Mechanical disc brake



UNDERCARRIAGE

Center frame x-frame
 Track frame Box-section
 Seal of track Sealed track
 Track adjuster Hydraulic
 Number of shoes (each side): 49
 Number of carrier rollers (each side): 2
 Number of track rollers (each side): 9



SERVICE REFILL CAPACITIES

Fuel tank 320 ltr **84.5 U.S. gal**
 Coolant 21.0 ltr **5.5 U.S. gal**
 Engine 23.1 ltr **6.1 U.S. gal**
 Final drive, each side 5.2 ltr **1.4 U.S. gal**
 Swing drive 7.1 ltr **1.9 U.S. gal**
 Hydraulic tank 126 ltr **33.3 U.S. gal**



OPERATING WEIGHT (APPROXIMATE)

Operating weight, including 5700 mm **18'8"** one-piece boom, 2925 mm **9'7"** arm, SAE heaped 0.80 m³ **1.05 yd³** backhoe bucket, operator, lubricant, coolant, full fuel tank, and the standard equipment.

Shoes		Operating Weight		Ground Pressure	
mm	in	kg	lb	kg/cm ²	psi
600 mm	24"	24130	53,195	0.51	7.28
700 mm	28"	24395	53,785	0.44	6.21
800 mm	31.5"	24675	54,405	0.39	5.62

PC228USLC-8 HYDRAULIC EXCAVATOR

SPECIFICATIONS (CONTINUED)



DIMENSIONS

	Arm length	2925 mm	9'7"
A	Overall length	8890 mm	29'2"
B	Overall height (to top of boom)	2780 mm	9'9"
C	Length on ground (transport)	5030 mm	16'6"
D	Overall width	3180 mm	10'5"
E	Overall height (to top of cab)	3050 mm	10'0"
F	Ground clearance, counterweight	1060 mm	3'6"
G	Ground clearance, minimum	440 mm	1'5"
H	Tail swing radius	1810 mm	5'11"
I	Track length on ground	3655 mm	12'0"
J	Track length	4450 mm	14'7"
K	Track gauge	2380 mm	7'10"
L	Width of crawler	3180 mm	10'5"
M	Shoe width	800 mm	31.5"
N	Grouser height	26 mm	1"
O	Machine cab height	2285 mm	7'6"
P	Machine cab width	2980 mm	9'9"
Q	Distance, swing center to rear end	1810 mm	5'11"

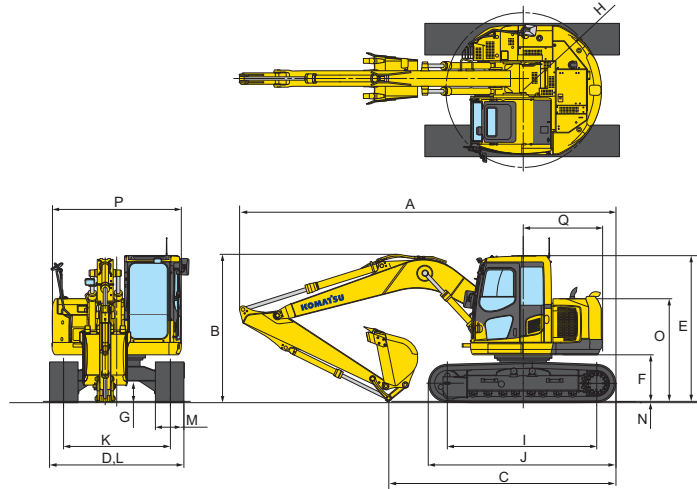

BACKHOE BUCKET, ARM, AND BOOM COMBINATION

Bucket Type	Bucket						Arms
	Capacity		Width		Weight		2.9 m 9'6"
Komatsu TL	0.50 m ³	0.66 yd ³	610 mm	24"	605 kg	1,334 lb	V
	0.67 m ³	0.88 yd ³	762 mm	30"	689 kg	1,518 lb	V
	0.85 m ³	1.11 yd ³	914 mm	36"	780 kg	1,719 lb	V
	1.02 m ³	1.34 yd ³	1067 mm	42"	857 kg	1,890 lb	W
	1.20 m ³	1.57 yd ³	1219 mm	48"	949 kg	2,092 lb	X
Komatsu HP	0.50 m ³	0.66 yd ³	610 mm	24"	652 kg	1,437 lb	V
	0.67 m ³	0.88 yd ³	762 mm	30"	763 kg	1,681 lb	V
	0.85 m ³	1.11 yd ³	914 mm	36"	868 kg	1,913 lb	V
	1.02 m ³	1.34 yd ³	1067 mm	42"	950 kg	2,095 lb	W
	1.20 m ³	1.57 yd ³	1219 mm	48"	1066 kg	2,349 lb	Y
Komatsu HPS	0.50 m ³	0.66 yd ³	610 mm	24"	724 kg	1,597 lb	V
	0.67 m ³	0.88 yd ³	762 mm	30"	840 kg	1,851 lb	V
	0.85 m ³	1.11 yd ³	914 mm	36"	962 kg	2,120 lb	V
	1.02 m ³	1.34 yd ³	1067 mm	42"	1061 kg	2,339 lb	X
	1.20 m ³	1.57 yd ³	1219 mm	48"	1193 kg	2,630 lb	Y
Komatsu HPX	0.50 m ³	0.66 yd ³	610 mm	24"	824 kg	1,817 lb	V
	0.67 m ³	0.88 yd ³	762 mm	30"	939 kg	2,071 lb	V
	0.85 m ³	1.11 yd ³	914 mm	36"	1061 kg	2,340 lb	W
	1.02 m ³	1.34 yd ³	1067 mm	42"	1161 kg	2,559 lb	X
	1.20 m ³	1.57 yd ³	1219 mm	48"	1293 kg	2,850 lb	Y

V – Used with material density up to 3,500 lb/yd³, W – Used with material density up to 3,000 lb/yd³
 X – Used with material density up to 2,500 lb/yd³, Y – Used with material density up to 2,000 lb/yd³, Z – Not useable



WORKING RANGE

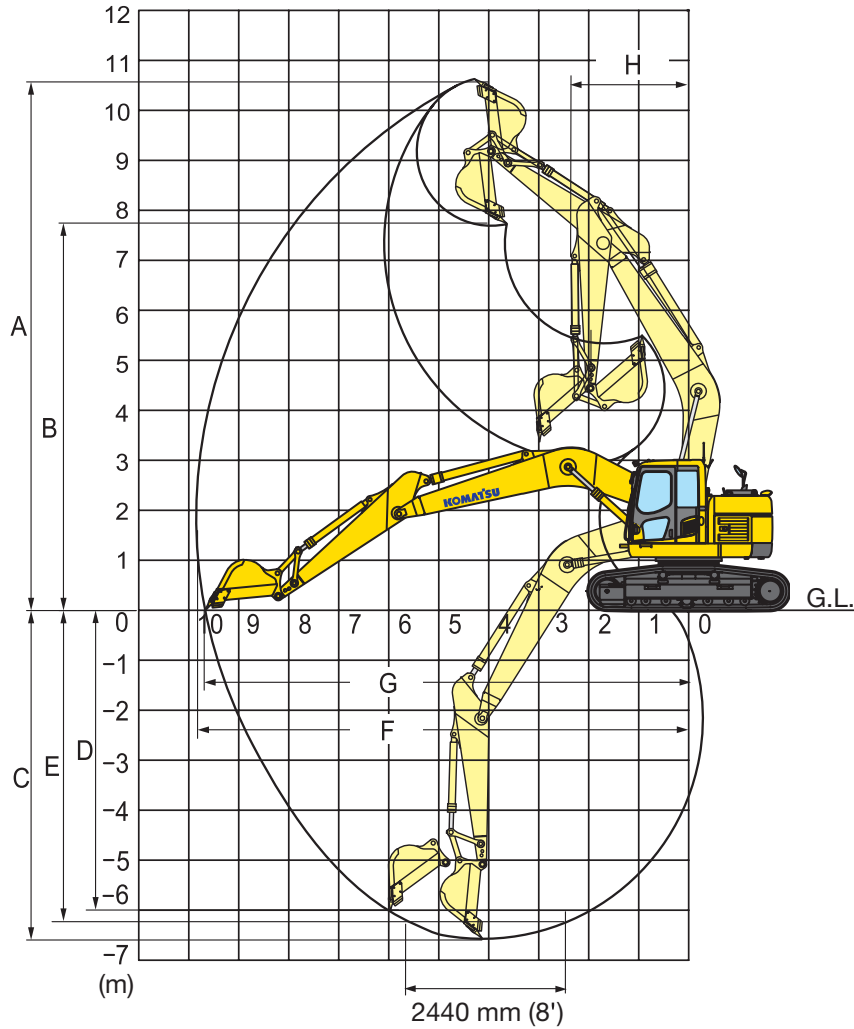

	Arm	2925 mm	9'7"
A	Max. digging height	10700 mm	35'1"
B	Max. dumping height	7825 mm	25'8"
C	Max. digging depth	6620 mm	21'9"
D	Max. vertical wall digging depth	5980 mm	19'7"
E	Max. digging depth 8' level bottom	6370 mm	20'11"
F	Max. digging reach	9875 mm	32'5"
G	Max. digging reach at ground level	9700 mm	31'10"
H	Min. swing radius	2310 mm	7'7"
SAE rating	Bucket digging force at power max.	138 kN 14100 kgf/31,085 lb	
	Arm crowd force at power max.	101 kN 10300 kgf/22,710 lb	
ISO rating	Bucket digging force at power max.	149 kN 15200 kgf/33,500 lb	
	Arm crowd force at power max.	108 kN 11000 kgf/24,250 lb	

LIFTING CAPACITIES



LIFTING CAPACITY

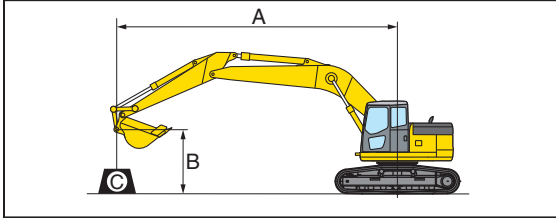

- A: Reach from swing center
- B: Bucket hook height
- C: Lifting capacity
- Cf: Rating over front
- Cs: Rating over side
- ☉: Rating at maximum reach

Conditions:

- Boom length: 5700 mm **18'8"**
- Bucket: 0.70 m³ **0.92 yd³**
- Bucket weight: 632 kg **1,395 lb.**
- Lifting mode: On

Arm: 2925 mm 9'7"		Shoe: 600 mm 24"								Unit: kg lb			
B	A	1.5 m 5'		3.0 m 10'		4.6 m 15'		6.1 m 20'		7.6 m 25'		☉ Maximum	
		Cf	Cs	Cf	Cs	Cf	Cs	Cf	Cs	Cf	Cs	Cf	Cs
6.1 m 20'								*5240 *11500	5230 11500			*2820 *6200	*2820 *6200
4.6 m 15'						*6570 *14400	*6570 *14400	*5970 *13100	5070 11100	*4880 *10700	3470 7600	*2840 *6200	*2840 *6200
3.0 m 10'				*13550 *29800	*13550 *29800	*9240 *20300	7640 16800	*7190 *15800	4840 10600	5550 12200	3360 7400	*2990 *6500	2790 6100
1.5 m 5'				*7380 *16200	*7380 *16200	*11820 *26000	7130 15700	7740 17000	4610 10100	5410 11900	3240 7100	*3290 *7200	2680 5900
0 m 0'				*5540 *12200	*5540 *12200	12110 26700	6800 15000	7530 16600	4430 9700	5310 11700	3150 6900	*3800 *8300	2730 6000
-1.5 m -5'	*5330 *11700	*5330 *11700	*9650 *21200	*9650 *21200	11950 26300	6670 14700	7420 16300	4330 9500	5260 11600	3100 6800		*4720 *10400	2970 6500
-3.0 m -10'	*9970 *21900	*9970 *21900	*16640 *36600	13320 29300	11980 26400	6700 14700	7420 16300	4330 9500				6020 13200	3550 7800
-4.6 m -15'			*16070 *35400	13650 30100	*11250 *24800	6880 15100						8630 19000	5030 11100

* Load is limited by hydraulic capacity rather than tipping. Ratings are based on ISO Standard No. 10567. Rated loads do not exceed 87% of hydraulic lift capacity or 75% of tipping load.

Arm: 2925 mm 9'7"		Shoe: 700 mm 28"								Unit: kg lb			
B	A	1.5 m 5'		3.0 m 10'		4.6 m 15'		6.1 m 20'		7.6 m 25'		☉ Maximum	
		Cf	Cs	Cf	Cs	Cf	Cs	Cf	Cs	Cf	Cs	Cf	Cs
6.1 m 20'								*5240 *11500	*5240 *11500			*2820 *6200	*2820 *6200
4.6 m 15'						*6570 *14400	*6570 *14400	*5970 *13100	5110 11200	*4880 *10700	3500 7700	*2840 *6200	*2840 *6200
3.0 m 10'				*13550 *29800	*13550 *29800	*9240 *20300	7700 16900	*7190 *15800	4880 10700	5600 12300	3390 7400	*2990 *6500	2820 6200
1.5 m 5'				*7380 *16200	*7380 *16200	*11820 *26000	7200 15800	7810 17200	1650 10200	5460 12000	3270 7200	*3290 *7200	2710 5900
0 m 0'				*5540 *12200	*5540 *12200	12220 26900	6870 15100	7600 16700	4470 9800	5360 11800	3180 7000	*3800 *8300	2760 6000
-1.5 m -5'	*5330 *11700	*5330 *11700	*9650 *21200	*9650 *21200	12060 26500	6740 14800	7490 16500	4370 9600	5320 11700	3140 6900		*4720 *10400	3000 6600
-3.0 m -10'	*9970 *21900	*9970 *21900	*16640 *36600	13440 29600	12090 26600	6760 14900	7490 16500	4370 9600				6070 13400	3580 7900
-4.6 m -15'			*16070 *35400	13770 30300	*11250 *24800	6940 15300						*8640 *19000	5080 11200

* Load is limited by hydraulic capacity rather than tipping. Ratings are based on ISO Standard No. 10567. Rated loads do not exceed 87% of hydraulic lift capacity or 75% of tipping load.



LIFTING CAPACITY (CONTINUED)

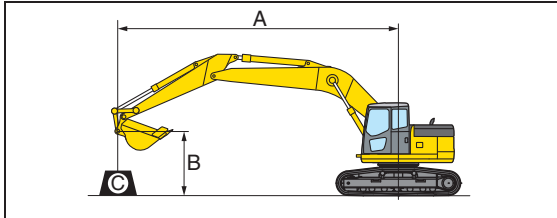

- A: Reach from swing center
- B: Bucket hook height
- C: Lifting capacity
- Cf: Rating over front
- Cs: Rating over side
- ⊗: Rating at maximum reach

Conditions:

- Boom length: 5700 mm **18'8"**
- Bucket: 0.70 m³ **0.92 yd³**
- Bucket weight: 632 kg **1,395 lb.**
- Lifting mode: On

Arm: 2925 mm 9'7"		Shoe: 800 mm 31.5"										Unit: kg lb	
B	A	1.5 m 5'		3.0 m 10'		4.6 m 15'		6.1 m 20'		7.6 m 25'		⊗ Maximum	
		Cf	Cs	Cf	Cs	Cf	Cs	Cf	Cs	Cf	Cs	Cf	Cs
6.1 m 20'								*5220 *11500	*5220 *11500			*2800 *6100	*2800 *6100
4.6 m 15'						*6550 *14400	*6550 *14400	*5950 *13100	5150 11300	*4860 *10700	3530 7700	*2820 *6200	*2820 *6200
3.0 m 10'				*13530 *29800	*13530 *29800	*9220 *20300	7760 17100	*7170 *15800	4920 10800	5650 12400	3420 7500	*2970 *6500	2840 6200
1.5 m 5'				*7360 *16200	*7360 *16200	*11810 *26000	7260 16000	7880 17300	4690 10300	5510 12100	3300 7200	*3270 *7200	2730 6000
0 m 0'				*5520 *12100	*5520 *12200	12340 27200	6930 15200	7680 16900	4510 9900	5410 11900	3210 7000	*3780 *8300	2780 6100
-1.5 m -5'		*5310 *11700	*5310 *11700	*9640 *21200	*9640 *21200	12180 26800	6800 15000	7570 16600	4410 9700	5370 11800	3160 6900	*4700 *10300	3030 6600
-3.0 m -10'		*9950 *21900	*9950 *21900	*16640 *36600	13580 29900	12220 26900	6830 15000	7560 16600	4410 9700			6130 13500	3610 7900
-4.6 m -15'				*16050 *35300	13910 30600	*11230 *24700	7010 15400					*8620 *19000	5130 11300

* Load is limited by hydraulic capacity rather than tipping. Ratings are based on ISO Standard No. 10567. Rated loads do not exceed 87% of hydraulic lift capacity or 75% of tipping load.



STANDARD EQUIPMENT

- Automatic air conditioner/heater
- Auto-decel
- Automatic engine warm-up system
- Alternator, 60 Ampere, 24V
- Batteries, large capacity
- Boom and arm holding valves
- Cab
- Converter, 12V
- Counterweight, 7360 kg **16,225 lb**
- Dry type air cleaner, double element
- Electric horn
- EMMS monitoring system
- Engine, Komatsu SAA6D107E-1
- Engine overheat prevention system
- Extended work equipment grease interval
- Fan guard structure
- Front work lights
- Fuel system pre-filter 10 micron
- High back suspension seat
- Hydraulic track adjusters (each side)
- KOMTRAX®
- Lock lever
- Mirrors (RH & LH)
- Multi-function color monitor
- Operator Protective Top Guard (OPG) Level 1
- Power maximizing system
- PPC hydraulic control system
- Pump/engine room partition cover
- Radiator and oil cooler dustproof net
- Rearview camera
- Revolving frame undercovers
- Seat belt, retractable 78 mm **3"** wide
- Service valve (1 additional)
- Slip resistant foot surfaces
- Starting motor, 5.5 kW
- Track frame undercover
- Track guiding guard (each side)
- Travel alarm
- Turbocharger exhaust manifold cover
- Working mode selection system



OPTIONAL EQUIPMENT

- Arm
 - 2925 mm **9'7"** arm
 - 2925 mm **9'7"** arm with piping
- Boom
 - 5700 mm **18'8"** HD boom
 - 5700 mm **18'8"** HD boom with piping
- Cab guards
 - Full front guard, OPG Level 1
 - Full front guard, OPG Level 2
 - Bolt-on top guard, OPG Level 2
- Hydraulic control unit
 - 1 additional actuator
- Pattern change valve (ISO to BH)
- Rain visor for cab
- Shoes
 - 600 mm **24"** road liner
 - 600 mm **24"** triple grouser
 - 700 mm **28"** triple grouser
 - 800 mm **31.5"** triple grouser
- Sun visor for cab



ATTACHMENT OPTIONS

- JRB attachments
 - Couplers
 - Smart-Loc
 - Versa-Loc
 - Komatsu buckets
 - PSM thumbs
 - Rockland thumbs
 - Rubber track shoes, Bolt-on type
- For a complete list of available attachments, please contact your local Komatsu distributor.

