



TM

Venieri
SPA

7.63C
9.63C

WHEEL
LOADERS





4K LINKAGE.

New completely redesigned linkage to the latest state of the art for **maximum breakout force**.



AUTO SAFETY IS OUR PRIORITY.

The **negative parking brake** is integrated into the front axle for maximum safety in all operating situations.



SILENCE, PLEASE.

By using new soundabsorbing materials and special “anti vibration” rubber shocks, **the noise inside cabin is radically reduced** guaranteeing **maximum comfort** to the operator.



360° BREATHTAKING VIEW.

The new ROPS/FOPS Level II cabin design guarantee a **360 ° visibility**, for **maximum work place control** and **highest level of safety**.



BE COOL.

The **brand new ventilation system** guarantees operator comfort. You can choose between **automatic climate control** or the **air conditioner**, thus obtaining the **perfect temperature in the cabin**.



100% VENIERI DESIGN.

In the new machines our **Venieri Design Center** follows the “family feelings” but introduces significant **stylistic innovations**.



TOTAL STABILITY.

Oscillating rear axle fixed to the frame with **maintenance-free** supports.

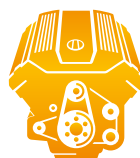

NEW DEUTZ TIER 4i/STAGE IIIB ENGINE

The new Deutz engine complies with the latest emission standards and delivers high torque at low rpm.



ALWAYS CLEAN AIR.

With the new air cleaner system, offering a **two stage filtration**, **high efficiencies pre-cleaner** plus **primary filters** and **safety filters**, we are improving engine protection to a maximum.



DOUBLE ATTENTION FOR SAVING.

The new electrically controlled **dual speed cooling fan**, adjusting the rotation speed according to working conditions, **reducing fuel consumption and noise.**



BUILT FOR POWER, DESIGNED FOR AGILITY.

The **special design of the counterweight** guarantees **perfect maneuverability**, **maximum drive angle** and protects the rear light system

7.63C

"Z" LINKAGE WHEEL LOADER



DIESEL ENGINE

4 cylinder in line engine, turbocharged with intercooler, common-rail injection with electronic control, exhaust gas recirculation, water cooled, dry filtration, oxidation catalyst (DOC). Emissioned according to CE 97/68 - Stage IIIB/Tier 4i.

Type	Deutz TCD 3.6 L4
Max. Power	94.5 kW - 128 HP
Rated	rpm 2.300
Power ISO/TR 14396	74,4 kW - 101 HP
Power EEC 80/1269	74,4 kW - 101 HP
Economic working range	rpm 1200 - 1800
Max. torque	Nm 410
Bore	mm 98
Stroke	mm 120
Displacement	cm ³ 3.620



ELECTRIC SYSTEM

Battery	12 Volt
Capacity EN 60095-1	110 Ah - 850 A
Alternator rating	95 A
Reverse warning	Standard
Wiring according to	IP 67 DIN 40050



TRANSMISSION

Hydrostatic transmission with automatic power regulation and closed circuit with pumps and variable displacement engine. Gearbox with 2 mechanical selections: 2 gear speeds (FWD/REV) and 2 road speeds (FWD/REV)

Work speed	Forward	Reverse
1 st gear km/h	0 ÷ 5	0 ÷ 5
2 nd gear km/h	0 ÷ 12	0 ÷ 12

Road speed	Forward	Reverse
1 st gear km/h	0 ÷ 18	0 ÷ 18
2 nd gear km/h	0 ÷ 40*	0 ÷ 40*

* Self limited max speed



AXLES

Two heavy duty equal size axles with planetary final drives in each wheel. Fixed rigid drive axle. Oscillation rear axle on rear chassis section up to a total angle of 25°. Transfer gearbox transferring movement directly to the rear and to the front axle via a transmission shaft. Self locking limited slip differential on front axle. Self locking limited slip differential on rear axle (optional).



BRAKES

Service: hydraulic multi-disc oil brake on front and rear axles. Parking brake: negative hydraulic on front axle, electrically applied.



TYRES

Standard	15.5 x 25
Option	405/70 R24 455/70 R24 15.5 R25



STEERING

Servo-assisted steering **LOAD SENSING** system.

Total steering angle	mm	80°
Inner tyres turning radius	mm	2.703
External tyres turning radius	mm	4.756
External bucket turning radius*	mm	5.270

* Bucket on traveling condition



HYDRAULIC SYSTEM

Two gear pump, the first for loader and steering circuit with **LOAD SENSING** valve, the second for the fan circuit with two rotating speed. Modular two-element control valve with main relief valve. Double acting hydraulic cylinders.

Hydraulic oil cooling radiator. Full flow oil filter on the drain pipe. Joystick control with 4 position lifting system and with 3 position bucket system.

Max. flow	lt/'	105
Max. flow with high flow (optional)	lt/'	130
Loader relief valve pressure	bar	250
Steering relief valve pressure	bar	175
Lift cylinder	mm	85x827
Bucket cylinder	mm	100x380
Lifting time (full)	sec.	5.1
Lowering time (empty)	sec.	3.1
Unloading time sec.	sec.	1.2
Total time of cyclus sec.	sec.	9.4



SERVICES CAPACITIES

Engine	lt	8
Front axle	lt	9,2
Rear axle	lt	9,1
Gear box	lt	1,8
Hydraulic circuit	lt	137
Brake circuit	lt	0,9
Fuel	lt	140
Water cooling	lt	20



TECHNICAL FEATURES

Standard bucket capacity	m ³	1,4
Bucket width	mm	2.250
Straight static tipping load	kg	5.600
Full turned tipping load 40°	kg	5.000
Lifting capacity at max. height	kg	5.600
Hinge pin height	mm	3.615 (3.565)*
Dump height at 40°	mm	2.890 (2.840)*
Reach at 40°	mm	845 (895)*
Breakout force	kg	9.100

*[...] With optional wheels 405/70 R24



DIMENSIONS AND WEIGHT

Max. length in transfer position	mm	5.900
Max. width in transfer position	mm	2.250
Tyre external width	mm	2.117
Track width	mm	1.710
Wheel base	mm	2.560
Ground clearance	mm	280 (230)*
Max height	mm	2.888 (2.838)*
Standard operating weight	kg	7.860 (7.600)*
Max. permissible weight	kg	8.350

*[...] With optional wheels 405/70 R24

dB NOISE LEVEL

Noise level inside cabin ISO 6396 - LpA	dB(A)	70
Exterior noise level ISO 6395 - LwA	dB(A)	101

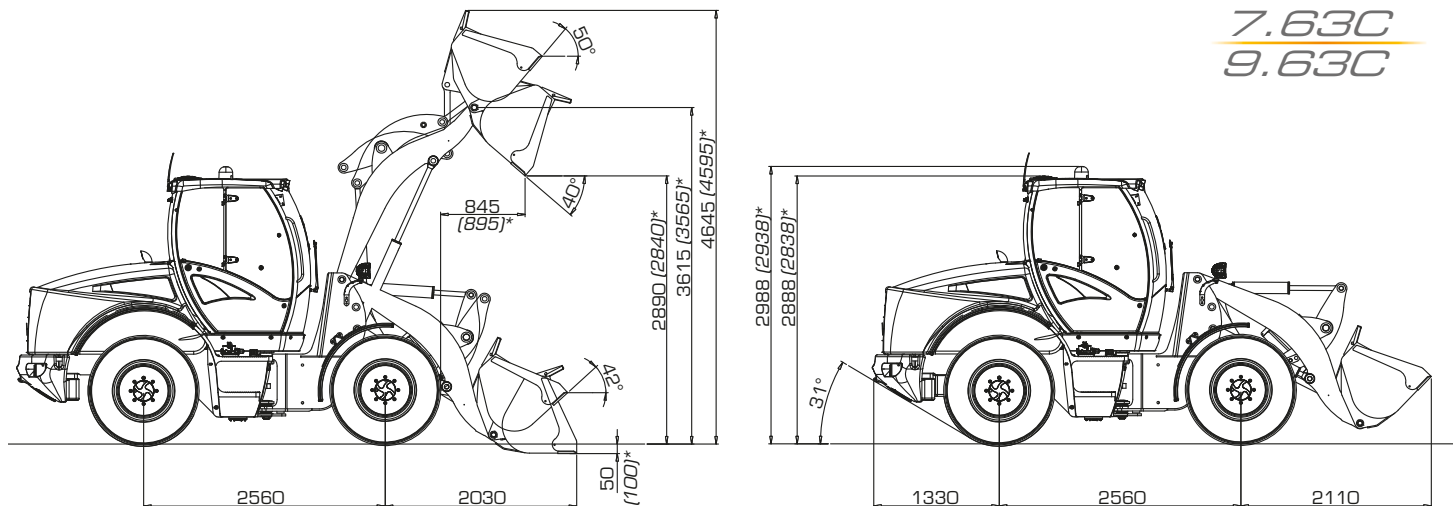

*[...] With optional wheels 405/70 R24

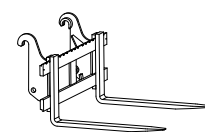

PERFORMANCE DATA

UNIVERSAL BUCKET

MULTI PURPOSE BUCKET

OVERSIZE

FORKS

Full load bucket capacity (SAE)	m ³	1,4	1,1	2,0	/
Bucket width	mm	2.250	2.250	2.500	/
Bucket weight	kg	500	600	600	/
Overall operating height, fully raised	mm	4.645 (4.595)*	4.560 (4.510)*	4.685 (4.635)*	/
Forks length (standard)					1000
Forks length (optional)					1200
Hinge pin height	mm	3.615 (3.565)*	3.615 (3.565)*	3.615 (3.565)*	/
Dump clearance	°	40°	40°	40°	/
Dump height	mm	2.890 (2.840)*	2.940 (2.890)*	2.840 (2.790)*	/
Dump distance	mm	845 (895)*	795 (715)*	885 (805)*	/
Max. dump distance	mm	1.150 (1.200)*	1.100 (1.150)*	1.200 (1.250)*	/
Bucket static tipping load, straight	kg	5.600	5.700	5.400	/
Bucket static tipping load, full turn	kg	5.000	5.100	4.800	/
Forks static tipping load, full turn	kg				3.750
Payload EN 474-3 (80%) [•]	kg				3.000
Payload EN 474-3 (60%) [•]	kg				2.250
Breakout force	kg	9.100	10.100	8.600	/
Total displacement length	mm	5.900	5.845	5.995	/
External bucket turning radius	mm	5.270	5.245	5.405	/
Standard operating weight	kg	7.860 (7.600)*	7.760 (7.500)*	7.960 (7.700)*	/

*[...] With optional wheels 405/70 R24 [•] Loading center 500mm

POWER

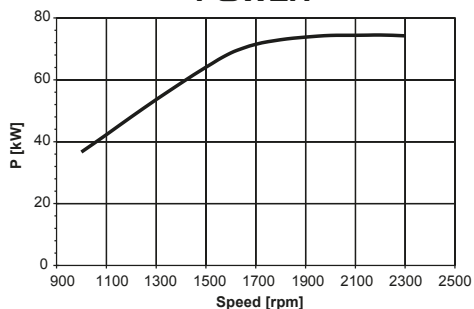

TORQUE

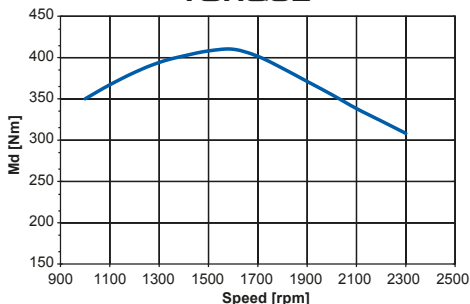

FUEL CONSUMPTION

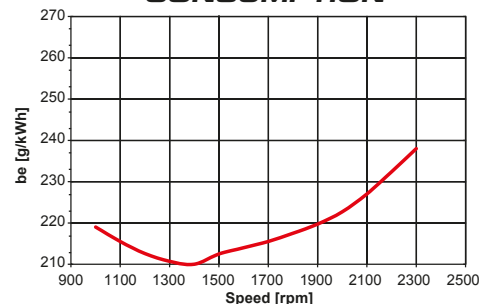

9.63C

"Z" LINKAGE WHEEL LOADER



DIESEL ENGINE

4 cylinder in line engine, turbocharged with intercooler, common-rail injection with electronic control, exhaust gas recirculation, water cooled, dry filtration, oxidation catalyst (DOC). Emissioned according to CE 97/68 - Stage IIIB/Tier 4i.

Type	Deutz TCD 3.6 L4
Max. power	94,5 kW - 128 HP
Rated	2.300
Power ISO/TR 14396	90 kW - 122 HP
Power EEC 80/1269	90 kW - 122 HP
Economic working range	rpm 1200 - 1800
Max. torque	Nm 480
Bore	mm 98
Stroke	mm 120
Displacement	cm ³ 3.620



ELECTRIC SYSTEM

Battery	12 Volt
Capacity EN 60095-1	110 Ah - 850 A
Alternator rating	95 A
Reverse warning	Standard
Wiring according to	IP 67 - DIN 40050



TRANSMISSION

Hydrostatic transmission with automatic power regulation and closed circuit with pumps and variable displacement engine. Gearbox with 2 mechanical selections: 2 gear speeds (FWD/REV) and 2 road speeds (FWD/REV).

Work speed	Forward	Reverse
1 st gear km/h	0 ÷ 5	0 ÷ 5
2 nd gear km/h	0 ÷ 13	0 ÷ 13

Road speed	Forward	Reverse
1 st gear km/h	0 ÷ 17	0 ÷ 17
2 nd gear km/h	0 ÷ 40*	0 ÷ 40*

* Self limited max speed



AXLES

Two heavy duty equal size axles with planetary final drives in each wheel. Fixed rigid drive axle. Oscillation rear axle on rear chassis section up to a total angle of 25°. Transfer gearbox transferring movement directly to the rear and to the front axle via a transmission shaft. Self locking limited slip differential on front axle. Self locking limited slip differential on rear axle (optional).



BRAKES

Service: hydraulic multi-disc oil brake on front and rear axles. Parking: negative hydraulic on front axle, electrically applied.



TYRES

Standard	17.5 x 25
Option	17.5 R25 480/70 R24



STEERING

Servo-assisted steering **LOAD SENSING** system.

Total steering angle	80°
Inner tyres turning radius	mm 2.733
External tyres turning radius	mm 4.908
External bucket turning radius*	mm 5.406

* Bucket on traveling condition



HYDRAULIC SYSTEM

Two gear pump, the first for loader and steering circuit with **LOAD SENSING** valve, the second for the fan circuit with two rotating speed. Modular two-element control valve with main relief valve. Double acting hydraulic cylinders. Hydraulic oil cooling radiator. Full flow oil filter on the drain pipe. Joystick control with 4 position lifting system and with 3 position bucket system.

Max. flow	lt/1'	155
Loader relief valve pressure	bar	230
Steering relief valve pressure	bar	175
Lift cylinder	mm100x815	
Bucket cylinder	mm120x380	
Lifting time (full)	sec.	4.6
Lowering time (empty)	sec.	3.5
Unloading time	sec.	1.8
Total time of cyclus	sec.	9.9



SERVICES CAPACITIES

Engine	lt	8
Front axle	lt	17,6
Rear axle	lt	11,9
Gear box	lt	1,8
Hydraulic circuit	lt	137
Brake circuit	lt	1,1
Fuel	lt	160
Water cooling	lt	20



TECHNICAL FEATURES

Standard bucket capacity	m ³	1,8
Bucket width	mm	2.350
Straight static tipping load	kg	6.200
Full turned tipping load	kg	5.500
Lifting capacity at max. height	kg	6.900
Dump clearance	mm	3.700
Dump height at 40°	mm	2.900
Reach at 40°	mm	815
Breakout force	kg	8.600



DIMENSIONS AND WEIGHT

Max. length in transfer position	mm	6.100
Max. width in transfer position	mm	2.350
Tyre external width	mm	2.195
Track width	mm	1.750
Wheel base	mm	2.635
Ground clearance	mm	380
Max. height	mm	2.980
Standard operating weight	kg	9.000
Max. permissible weight	kg	9.670

dB NOISE LEVEL

Noise level inside cabin ISO 6396 - LpA	dB(A)	70
Exterior noise level ISO 6395 - LwA	dB(A)	101

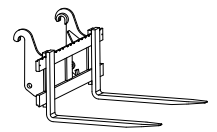
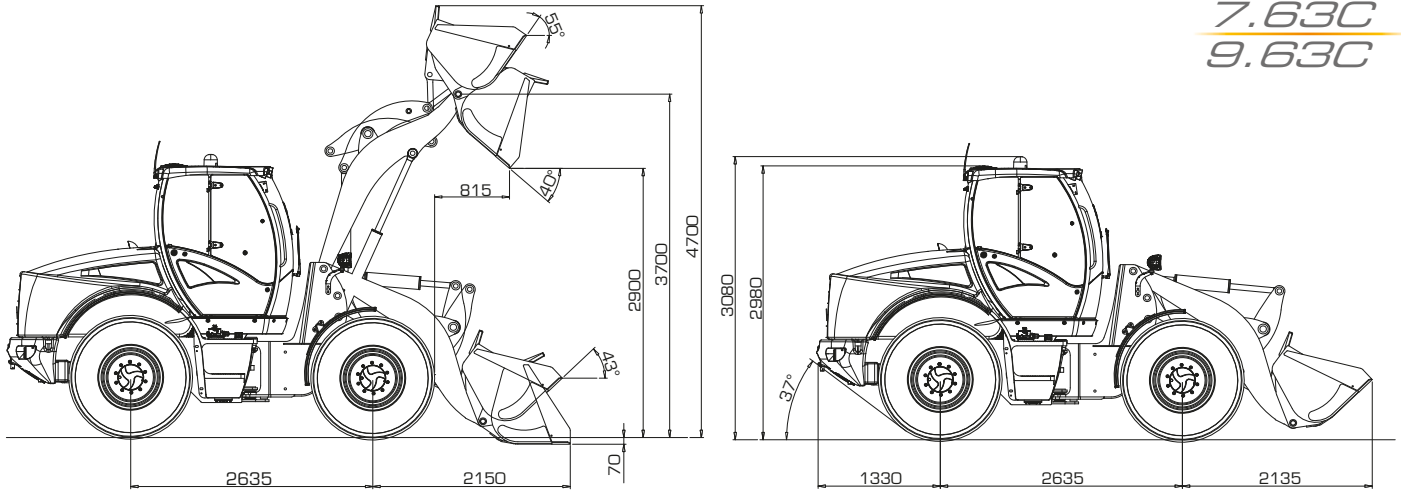

PERFORMANCE DATA

UNIVERSAL BUCKET

MULTI PURPOSE BUCKET

OVERSIZE

FORKS

Full load bucket capacity (SAE)	m ³	1,8	1,3	2,2	/
Bucket width	mm	2.350	2.350	2.500	/
Bucket weight	kg	650	750	750	/
Overall operating height, fully raised	mm	4.700	4.646	4.796	/
Forks length (standard)					1100
Forks length (optional)					1300
Hinge pin height	mm	3.700	3.700	3.700	/
Dump clearance	°	40°	40°	40°	/
Dump height	mm	2.900	2.950	2.833	/
Dump distance	mm	815	800	924	/
Max. dump distance	mm	1.145	1.095	1.219	/
Bucket static tipping load, straight	kg	6.200	6.300	6.000	/
Bucket static tipping load, full turn	kg	5.500	5.600	5.300	/
Forks static tipping load, full turn	kg				4.600
Payload EN 474-3 (80%) [•]	kg				3.680
Payload EN 474-3 (60%) [•]	kg				2.760
Breakout force	kg	8.600	9.600	7.800	/
Total displacement length	mm	6.100	6.045	6.175	/
External bucket turning radius	mm	5.406	5.381	5.531	/
Standard operating weight	kg	9.000	9.100	9.100	/

[•] Loading center 500mm

POWER

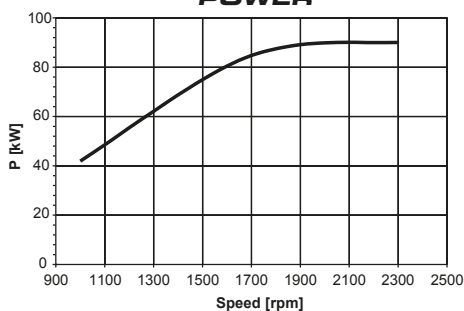

TORQUE

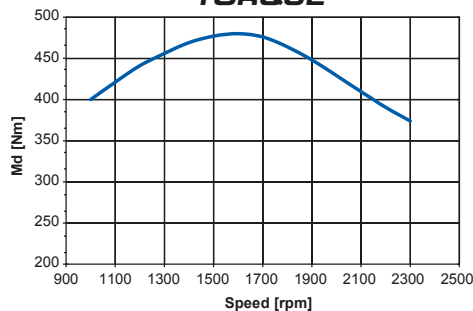

FUEL CONSUMPTION

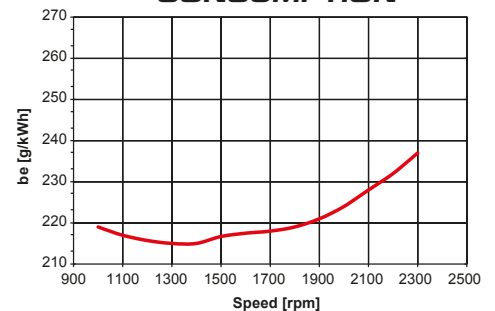

THE NEW CABIN

A BREATHTAKING VIEW.

Take a seat in your customized control room. Create your ideal work space by **adjusting** the **pneumatic seat** and the **steering wheel** to suit your specific needs. Select the commands, **all at your fingertips**. Excellent **visibility to 360°** gives you the best view to work with maximum efficiency. The combination of **breathtaking cabin** and the **latest state of the art of 4K linkage** allows the **maximum control** of your attachments.

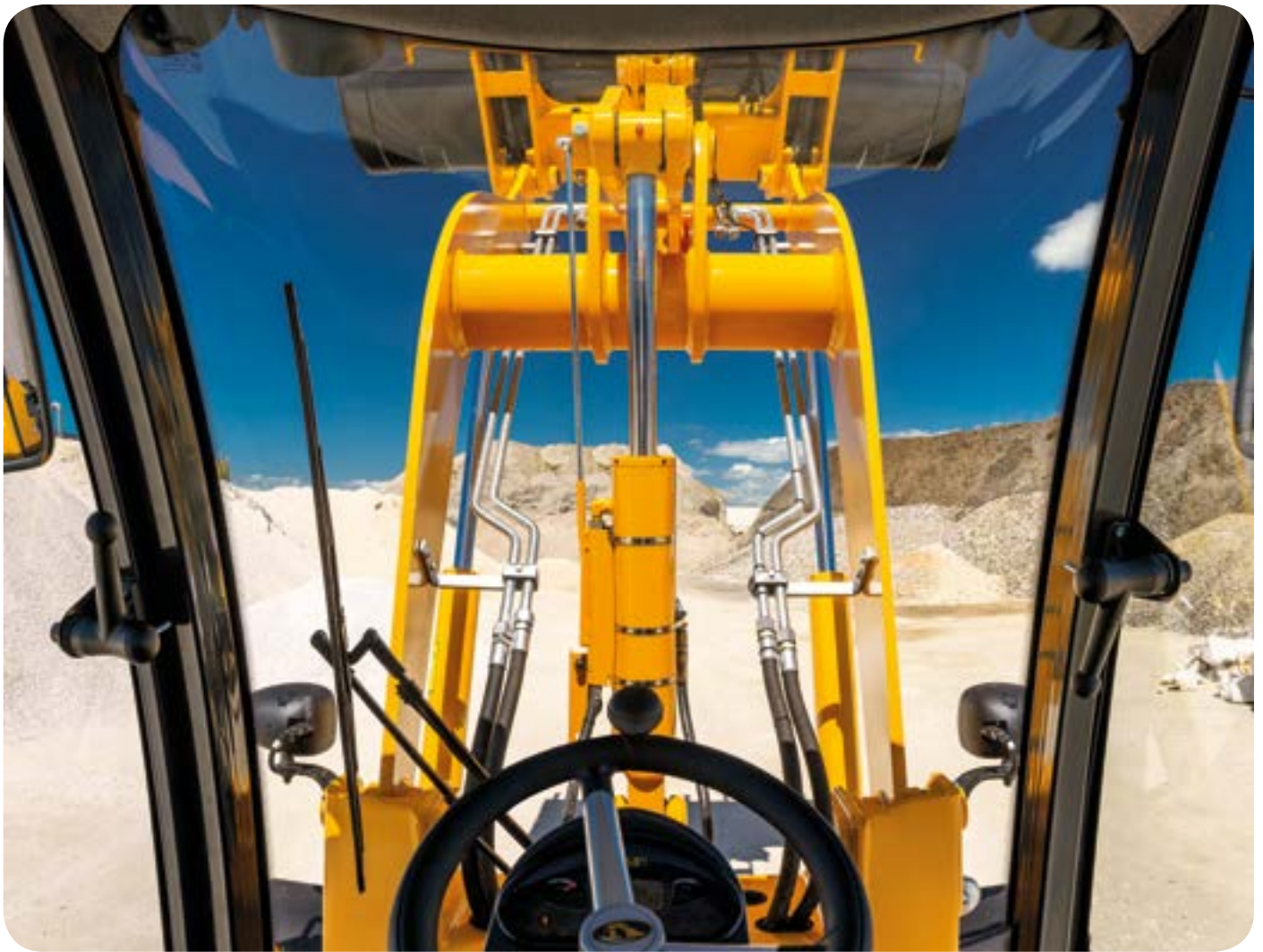

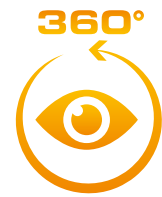
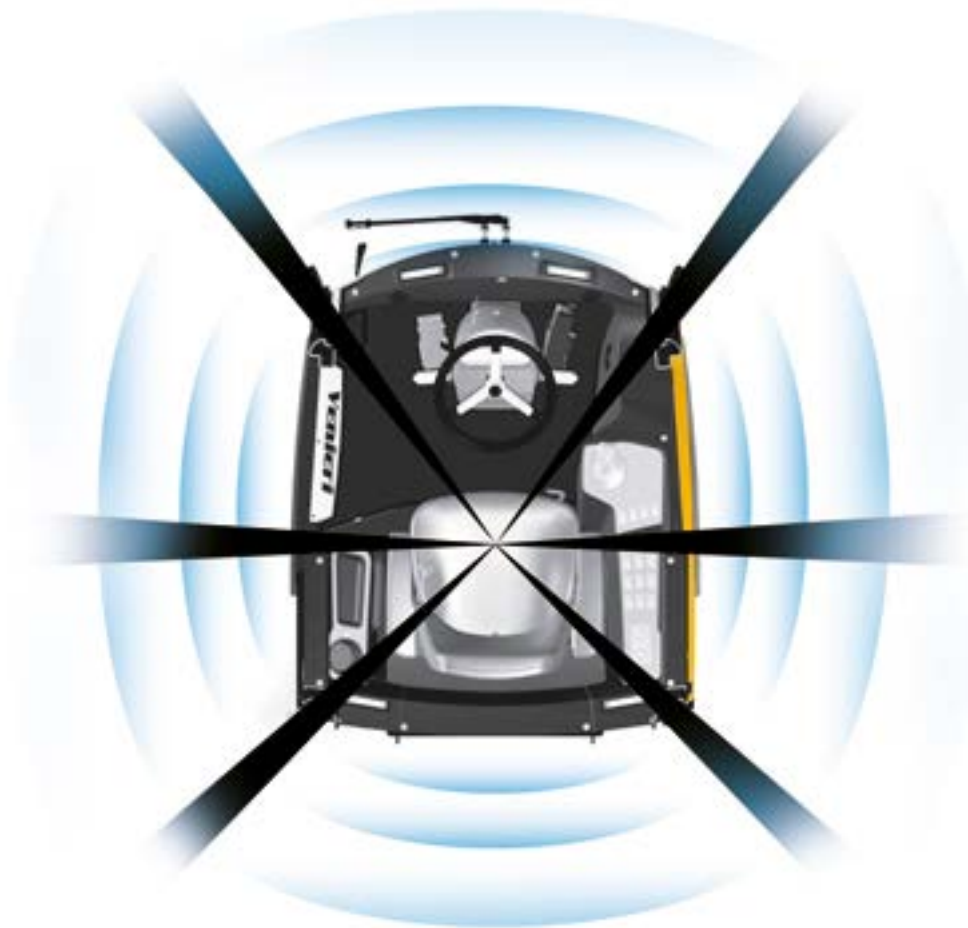

In the new VF 7.63C and 9.63C cabin we **minimized "blind spots"** for **superb visibility** in all working conditions.

OPEN SESAME!

The **door with double opening** allows the operator to work with the entrance door closed, with top glass opened, ensuring **maximum ventilation** even with the A/C off and **without protruding parts out of shape**.



BEAUTY FINALLY MEETS FUNCTIONALITY.

The Venieri Design Centre, with the VF 7.63C and VF 9.63C nwe cab tried to merge **function** and **style** with the aim of become the best in the market. The new interior design has also allowed us to create different compartments useful for storing small tools, mobile phone, beverage, and more.



ARTIFICIAL INTELLIGENCE.

Advanced man/machine interface, which constantly **monitors the performance of the machine** and communicates **each diagnosis** to the operator via a large and detailed LCD screen in the dashboard.

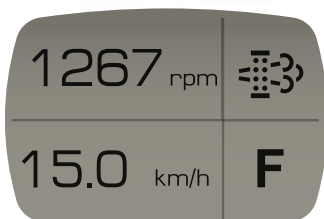

LAYOUT A

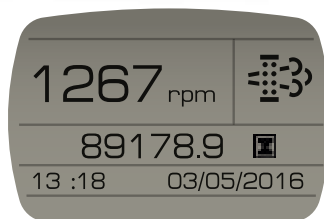

LAYOUT B

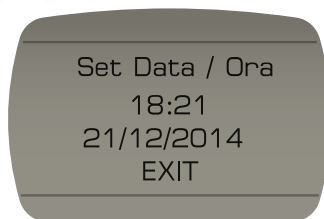

SETTINGS

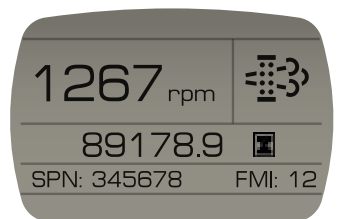

ENGINE ERROR

BE COOL.

The entire ventilation system has been redesigned according to **ISO10263** also ensuring easy maintenance to the heating and A/C unit. Using a single dashboard, the operator can choose the ideal temperature, ensuring **maximum working comfort**. (The VF 7.63C and VF 9.63C can be equipped with **Venieri Climatronic**).

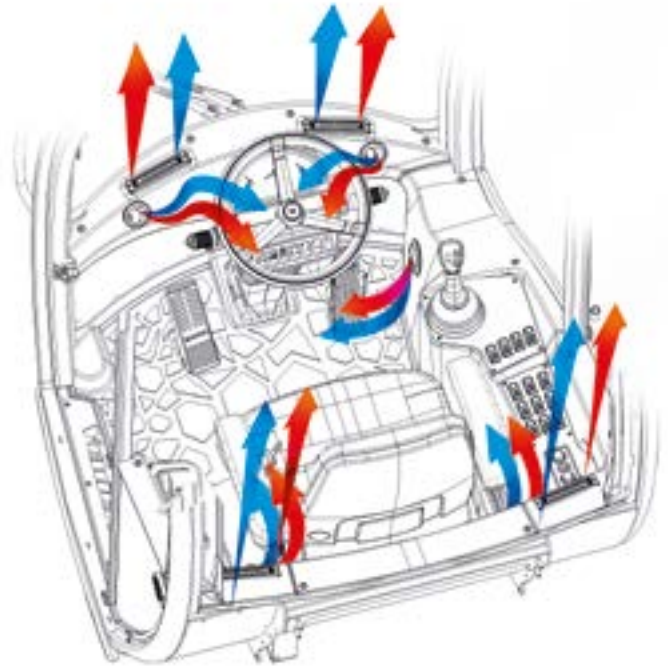
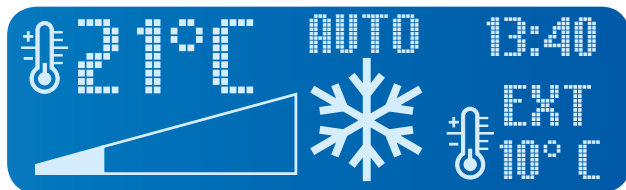
**THE BLACK BOX.**

For the first time on a Venieri cabin, all electrical control are positioned in a **waterproof** position accessible only from inside the cabin, easy to access and complete all diagnostics.

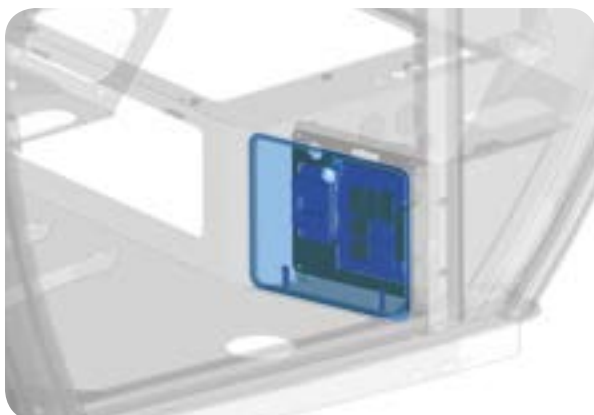
**ENJOY THE SHOW.**

The driver's seat is equipped with the **most advanced solutions in terms of comfort** for maximum operational efficiency.



CLASS EVOLUTION

CLEAN POWER, ZERO CONSUMPTION. NEW DEUTZ TIER 4/STAGE IIIB ENGINES

The VF 7.63C and VF 9.63C is powered by the **new Deutz TCD 3.6 L4, a 3,620 cc** four cylinder unit **awarded as best engine in his class**. The impressive performance, reliability and durability distinguishing this engine have been made possible by adopting the most advanced technology, such as: **electronically controlled Common Rail injection, a turbocharger with intercooler and wastegate valve, and a proportional speed viscostatic fan**, to mention but a few. The result is a minimum specific fuel consumption of **just 210 g/kWh** - an outstanding figure for an engine of this size - which, through the use of an external gas recirculation system and the diesel oxidatation catalyst (**DOC**) compliance with the **Tier 4i** emissions regulations and achieved.

› COMMON RAIL

In Deutz engines, injection pressures of **1,600 bar** ensure that the fuel is atomised perfectly for **maximised combustion efficiency**, which not only **reduces fuel consumption** but also **increased torque and power**.

› THE DOC CATALYST

The **DOC** (Diesel Oxidation Catalyst) installed above the engine is a **catalytic converter** which **transforms the most undesirable components of the exhaust gas into substances that are harmless for the environment**. Unlike a conventional DPF (Diesel Particulate Filter), the DOC does not require energy-costly active regeneration cycles works with no additive reagents, they are also **maintenance-free**.

› ENGINE MANAGEMENT

To avoid unnecessary and unproductive fuel consumption, the engine **is managed entirely electronically**, to deliver only the power effectively needed for the job in hand.



9.63C Deutz TCD 3.6 L4
94,5 kW - 128 CV

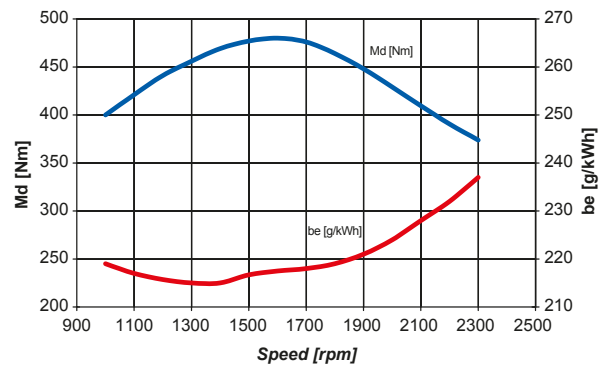
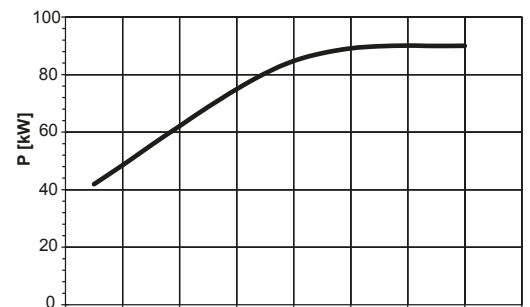

7.63C Deutz TCD 3.6 L4
78 kW - 106 CV

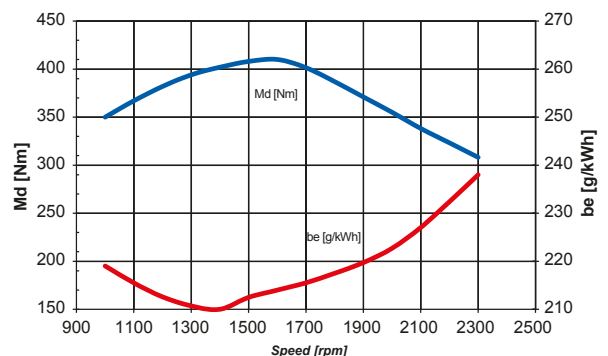
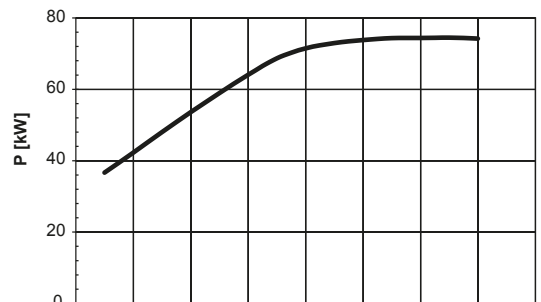

SILENCE, PLEASE.

The noise inside the new cab is simply **extraordinary. With only 70 dB.**



VROOOOOOOOM!

Driving speed **40 km/h** self-limited. We are in the Motor Valley and the speed is not an option. [limited to specific country regulation (TUV)].



MAXIMUM POWER EXACTLY WHERE YOU NEED IT.

A lot of power for the hydraulic system and, at the same time, a reduction of the travel speed. For these reasons VF 7.63C and 9.63C wheel loaders need a single pedal. The brake pedal with **inching function** can control both the mechanical brake both the hydraulic (inching). Real advantages are **less wear of the service brake** and **optimum distribution of engine power**.



No pressure
on the inching/brake pedal:
maximum power for traction.



Normal pressure
on the inching/brake pedal:
the speed reduction, the more power
the hydraulic system service.



Maximum pressure
on the inching/brake pedal:
the wheel loader stops,
maximum strength to the plumbing.

Venieri GLOBAL

Venieri GLOBAL™ is the newest Venieri monitoring system by Satellite allowing increase productivity, providing detailed information on the fleet and equipment, as well as an incredible amount of data to ensure the highest levels of performance and greater economic efficiency.

- › FLEET MANAGEMENT
- › MONITORING FLEET
- › CONTROL MACHINE STATUS



MONITORING FLEET



PRODUCTIVITY REPORT



Available, on WINDOWS, MAC, iOS and Android.



REPORT ALARMS



ENGINE ON/OFF



BASIC MACHINE



Battery main switch	•	•
Tool box	•	•
Fuel preheating (cold climates)	0	0
Plugs with keys for fuel and hydraulic tanks	•	•
Proportional self lock front differential	•	•
Proportional self lock rear differential	0	0
Differential lock 100 % engageable in front axle	0	0
Trailer coupling	•	•
Warning beacon	•	•
Soundproofing	•	•
Spare parts catalogue	•	•
User manual	•	•
Type-approval for road traffic	•	•
Safety clamp for bucket and lifting cylinders	•	•
Autolevelling ground level for bucket	•	•
Speed reduction kit	0	0
„Venieri GLOBAL“ system	0	0
Double-speed hydraulic fan	•	•
Reversible fan (for radiator cleaning)	0	0
Hydraulic negative parking brake	•	•
Service brake on both axles with separate circuits	•	•
Inch pedal integrated in brake pedal	•	•
Greasing points grouped on the frame	•	•
Automatic centralized greasing system	0	0
Ride control	0	0
Engine preheating system	0	0
Environmentally-friendly hydraulic oil	0	0
Hydraulic oil ISO 46 (cold climates)	0	0
Cyclone dust separator	•	•

CABIN EQUIPMENT



ROPS/FOPS 2nd Level, pressurized and soundproofed	•	•
Front and rear windscreen wiper with washer	•	•
Halogen work lights (4 front + 2 rear)	•	•
LED work lights (4 front + 2 rear)	0	0
Mobile phone compartment	•	•
Bottle holder	•	•
Document compartment	•	•
Seat with mechanical suspension	•	•
Seat with pneumatic suspension	0	0
Seat with pneumatic suspension and heating	0	0
Seat armrests	•	•
Buzzer	•	•
Cabin carpet	•	•
Clothes hangers	•	•
Radio preparation	•	•
Supplementary socket 12V	•	•
Manual Air Conditioning	0	•
„Climatronic Venieri“ system	0	0
Ceiling lamp	•	•
Sun visor	•	•
Rear view mirrors	•	•
Heatable rear view mirrors	0	0
First-aid kit	0	0
Fire extinguisher 2kg	0	0
Seat belt	•	•
Instrumentation and dashboard with LCD display	•	•
Safety glass breaker	•	•

SPECIAL EQUIPMENT



Hydraulic or mechanical quick coupler	0	0
Cement mixing bucket	0	0
Multipurpose bucket (4 in 1)	0	0
Lifting forks	0	0
Asphalt and cement planer	0	0
Snow blower	0	0
Snow blade and „V“ type snow blade	0	0
Angle-tilt dozer blade	0	0
Hand operating hammer	0	0
Polishing brush	0	0
Trencher	0	0
High tip bucket	0	0
high flow kit	0	-
Unpressurized return pipe	0	0
Double auxiliary line	0	0
Rear hydraulic line (single effect)	0	0



UP7630963C_B-GB (2017) proartigrafica.it



Via Piratello, 106 - 48022 Lugo (RA) - ITALY
Tel. +39 0545 904411 Fax +39 0545 30389
e-mail: info@vf-venieri.com | www.vf-venieri.com

Spare Parts
Tel. +39 0545 904429 Fax +39 0545 24555
e-mail: ricambi@vf-venieri.com