

Lifting capacity

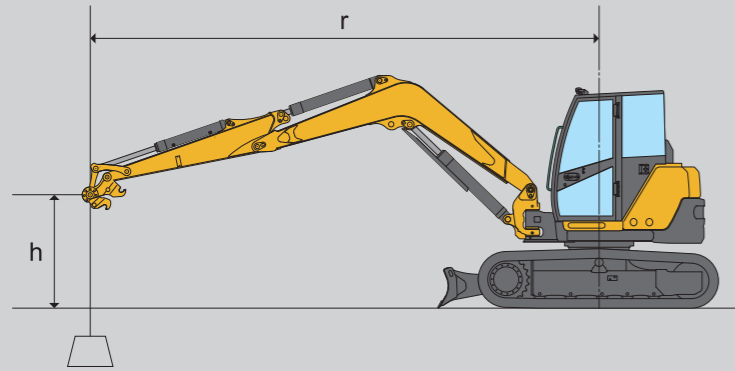

Never allow total bucket weight to exceed excavator lift capacity.

Note where applicable specifications conform to ISO standards.
 Loads shown in table include weight of standard bucket (430 lbs. [195kg])
 Weight of all lifting devices and attachment must be deducted to determine load can that be lifted.
 Lift point is bucket hinge point with bucket fully curved.
 Specifications subject to change without notice.

Model SV100-2B excavator quick coupler spec.

*Rated hydraulic lift capacity.

LIFT POINT HEIGHT h ft-in (mm)	(r) LIFT RADIUS ft-in (mm)											
	RATED LIFT CAPACITY OVER END BLADE DOWN lbs (kg)				RATED LIFT CAPACITY OVER END BLADE UP lbs (kg)				RATED LIFT CAPACITY OVER SIDE BLADE UP lbs (kg)			
	MAX	16'5" (5000)	13'1" (4000)	9'10" (3000)	MAX	16'5" (5000)	13'1" (4000)	9'10" (3000)	MAX	16'5" (5000)	13'1" (4000)	9'10" (3000)
16'5" (5000)	*3925 (1780)				*3925 (1780)				3153 (1430)			
13'1" (4000)	*3947 (1790)	*3771 (1710)	*3837 (1740)		3087 (1400)	*3771 (1710)	*3837 (1740)		2558 (1160)	*3771 (1710)	*3925 (1780)	
9'10" (3000)	*3925 (1780)	*3925 (1780)	*4520 (2050)		2646 (1200)	*3925 (1780)	*4520 (2050)		2183 (990)	3153 (1430)	*4520 (2050)	
6'7" (2000)	*3947 (1790)	*4586 (2080)	*5468 (2480)		2492 (1130)	3616 (1640)	*5468 (2480)		2029 (920)	2911 (1320)	4256 (1930)	
3'3" (1000)	*4145 (1880)	*5005 (2270)	*6813 (3090)	*9989 (4530)	2602 (1180)	3462 (1570)	5005 (2270)	7387 (3350)	1985 (900)	2822 (1280)	4079 (1850)	5821 (2640)
Ground (0)	*4079 (1850)	*5490 (2490)	*7078 (3210)	*10033 (4550)	2690 (1220)	3418 (1550)	4741 (2150)	7254 (3290)	2183 (990)	2756 (1250)	3881 (1760)	5799 (2630)
-3'3" (-1000)	*4145 (1880)	*5226 (2370)	*6858 (3110)	*9415 (4270)	2889 (1310)	3352 (1520)	4653 (2110)	7321 (3320)	2293 (1040)	2734 (1240)	3726 (1690)	5733 (2600)
-6'7" (-2000)	*4057 (1840)		*5865 (2660)	*8203 (3720)	3418 (1550)		4719 (2140)	7078 (3210)	2911 (1320)		3793 (1720)	5887 (2670)

Standard equipment

- Hydraulic quick coupler
- Blade
- Boom swing function
- Rubber track / Steel track
- Auxiliary valve and plumbing
- Radio antenna and connection harness
- Back mirror / Side mirror
- 2-way control pattern change
- ROPS / OPG Cabin
- Windshield washer
- Air conditioner
- Defroster
- Joystick pilot controls
- Arm rests (adjustable)
- Suspension and reclining seat
- Seat belt
- P.T.O switch
- Travel automatic dual speed switch
- Auto deceleration switch
- Eco mode switch
- Engine stop switch
- Traveling alarm
- Floor mats
- Evacuation hammer

(Please note that the standard equipment may vary from this list. Consult your Yanmar dealer for confirmation)

YANMAR
 Solutioneering Together

ULTRA-TIGHT TURNING EXCAVATOR

SV100-2
 54.7kW(73.3hp)



YANMAR CONSTRUCTION EQUIPMENT CO.,LTD.

OVERSEAS SALES DEPT.
 MARKETING & SALES DEPT.
 1717-1, Kumano, Chikugo, Fukuoka 833-0055, Japan
 Tel: +81-942-53-5465 Fax: +81-942-53-5132
 http://yanmar.com

All data subject to change without notice.

Printed in Japan
 031D0-G00810 1406

YANMAR - YOUR BEST PARTNER FOR BUILDING THE FUTURE

EVOLUTION

YANMAR. On the job around the world.
Our highly regarded technical expertise creates the value you need.



Clean diesel engine



Ultra-tight turning



Comfort



Operator control



Quick coupler



Safety



Easy maintenance

Cleaner emissions and reduced noise confirm YANMAR's commitment to superior environmental performance. Operating in the stress-free comfort of a spacious cabin is sure to increase productivity. And the evolution of the excavator is apparent in the SV100-2's enhanced operator environment, reliability and component durability. Work "quick, smooth and smart" on every worksite. Super comfort and ease of use make it happen. Working in harmony with YANMAR - the future looks bright.

ULTRA-TIGHT TURNING EXCAVATOR

SV100
SV100-2

CLEAN DIESEL ENGINE

Combining long experience and unrivalled expertise, **YANMAR's diesel technology ensures environmental performance and high efficiency.**

A high-power, eco-friendly engine meeting Tier 3 emissions regulations.

The YANMAR TNV direct injection diesel engine was built for clean emissions and powerful output. With its improved fuel injection system, it meets Tier 3 emissions regulations of the US Environmental Protection Agency (EPA) and the European Commission (EC). Its quiet operation makes it both people- and planet-friendly.



4TNV98T

54.7kW / 2200rpm

Electronically controlled water-cooled EGR* system reduces air-polluting nitrogen oxides (NOx).

This system cools a portion of the exhaust gases and mixes them with intake air to lower the concentration of oxygen in air intake. That drops the combustion temperature, limits NOx emissions and boosts fuel efficiency.

*EGR : Exhaust Gas Recirculation

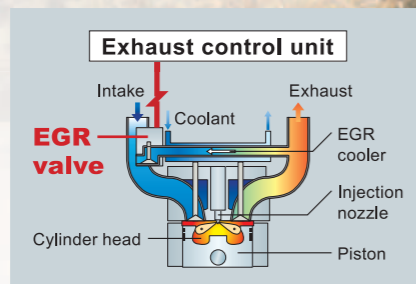

Fuel efficiency.

Fuel efficiency has improved due to the excellently matched hydraulic system combined with the features of Eco mode and Auto deceleration, making it them the most fuel efficient excavator in their class.

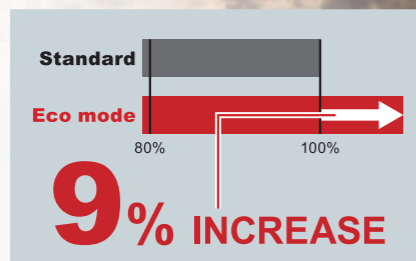

Eco mode.

Switching to this controls the engine speed for efficiency and greatly reduces fuel consumption.



Auto deceleration.

Switching the operating levers to neutral automatically drops the engine rpm and reduces on both fuel consumption and noise.

Auto deceleration switch



ULTRA-TIGHT TURNING

The combination of creative body design and reliable power provides ultra-tight turning for increased versatility and greater work efficiency.



Min. swing radius	Min. boom swing radius	Tail swing radius
2,790	2,390	1,330
mm	mm	mm
(9'2")	(7'10")	(4'4")



Minimal rear overhang allows operators to turn from side to side without worry of walls.

The SV100-2 is equipped with a boom swing designed not to stick out beyond the track. The ultra-tight turning permits operation in narrow places on a variety work sites.

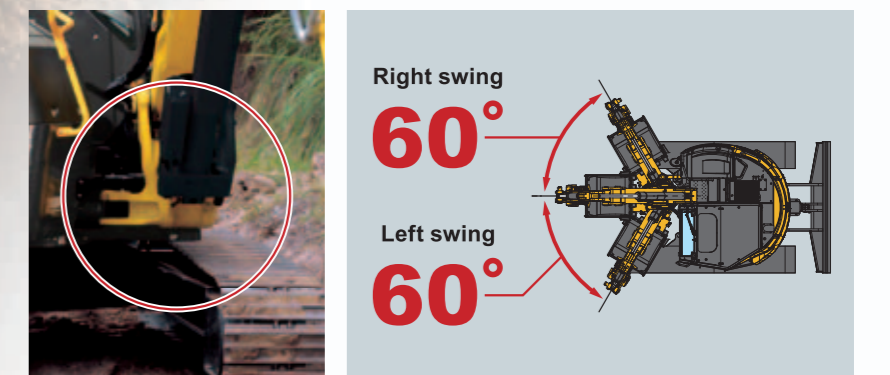

COMFORT

Climate control and sound reduction features create more comfortable working conditions all-year around.



SPACIOUS CABIN

Large, comfortable cabin provides plenty of operating space.

The SV100-2 features a spacious cabin that offers improved comfort for the operator. Operators have great visibility through a wide front glass that slides up and down for easy communication with people outside. There is plenty of leg room, and its wide door provides easy entry.



Cab width
800mm (2'7")



Entrance
730mm (2'5")

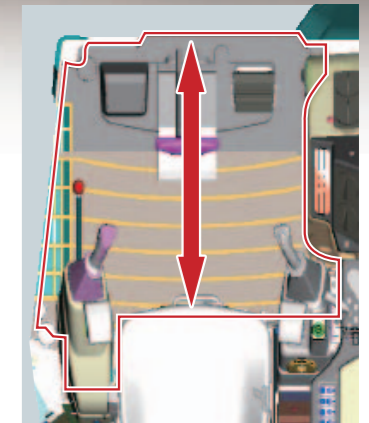

Leg room
700mm (2'4")

AIR-CONDITIONER

Multi-functional air conditioner.

The SV100-2 is equipped with a powerful air conditioner that features defroster, Air Recirculation and Outside Air modes to provide a pleasant work atmosphere all year round.

Air Recirculation and Outside Air modes.

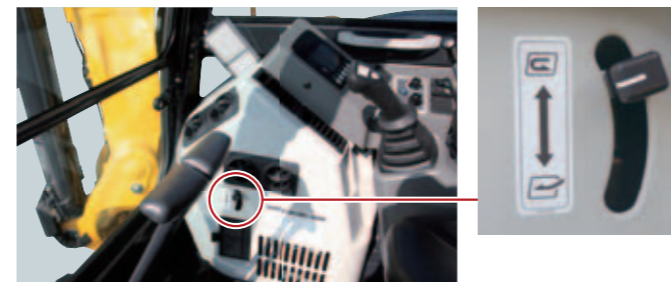

A / C using outside Air + Defroster function enable comfort on the job.



A/C Control Panel



Defroster

LOW-NOISE CABIN

Quiet cabin environment for reduced operator stress.

Designed using sturdy, sound-reducing, advanced anti-vibration technology, the SV100-2 provides the quietest operation environment yet. The noise level inside the cab is just 73dB(A), greatly reducing fatigue over long hours of work.

73
dB(A)

Liquid-Filled cab anti-vibration mount for excellent sound blocking and comfortable ride.

The five-point support provides efficient absorption of heavy vibration. This diminishes cabin noise and operator stress on the job.

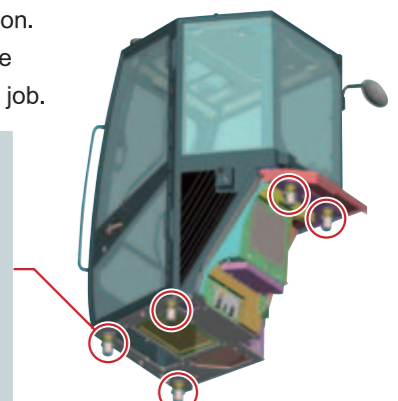
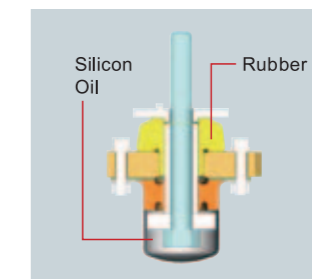

OPERATOR CONTROL

Brimming with comfort and ease of use, the SV100-2 is a perfect fit from the operator's vantage point.

1 Advanced product support with new operation control system.

The new LCD action monitor provides various information, including machine service life and servicing alerts for smart machine maintenance.

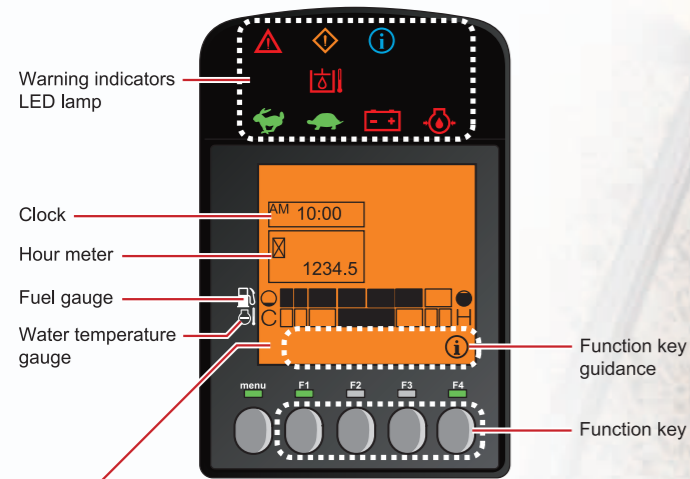

LCD monitor display examples



2 Wrist control levers + adjustable arm rests.

Wrist control lever are easy to grasp, and arm rests can be repositioned to meet the operator's preferences and work posture, reducing fatigue even after long hours of operation.

3 PTO proportional control with hold button & PTO adjust.

PTO flow adjustment system corresponds to variable attachments. The operator's tiredness by the PTO work for a long time is reduced by the holding switch.

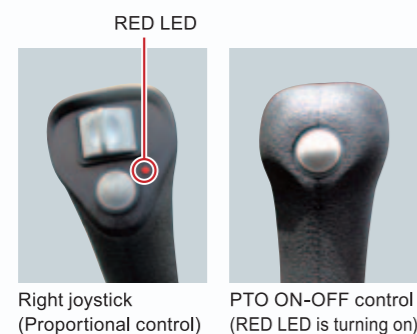

4 Automatic two-speed travel system switches from high speed to low when handling heavy loads and returns to high speed when load lightens.

5 Blade lever, travel lever and travel pedal are all hydraulic controlled to provide light and smooth operation.

6 Large travel pedals are easy to press.

7 Double-slide seat mechanism for relaxed operation.

Not just the seat, but the operating levers and seat can slide back and forth simultaneously, enabling optimal lever position and operating posture for the operator's body type.

8 Retracting seat belt is easy to buck and stays out of the way when not in use.

(The ROPS protective structure assumes the operator is wearing a seatbelt)

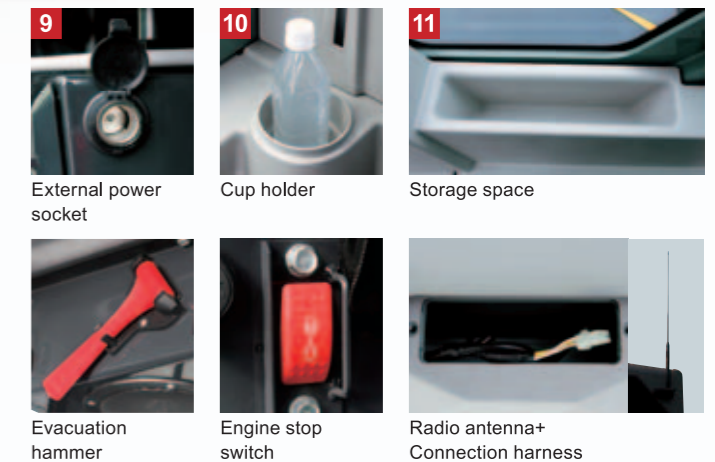

QUICK COUPLER

Hydraulic quick coupler allows for quick and dirt free bucket and removal.

The quick coupler makes the once troublesome task of changing buckets fast and easy without even getting your hands dirty. It's all performed by switch operation while you remain seated, except for fitting and removal of the safety lock pin. You can also use attachments made by other companies, thereby reducing storage costs and saving space.

Bucket removal

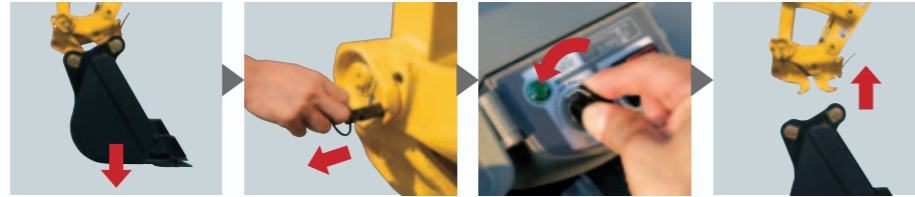

Place the bucket on the ground Pull out the safety lock pin Turn the switch to dismounting. Raise the arm to detach.

Bucket attachment

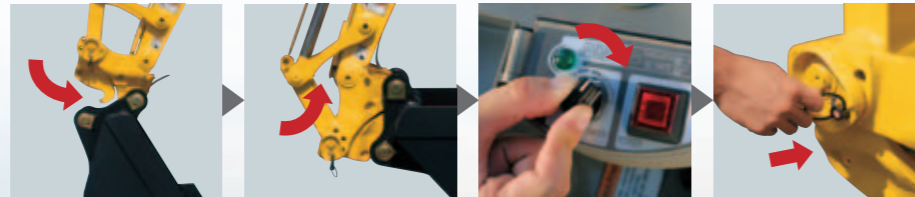

Apply the fixed hook Make the bucket level. Turn the switch to mounting Insert the safety lock pin and fasten.



Quick coupler control box



Movable hook

Fixed hook

SAFETY

Dependable and sturdy, the SV100-2 delivers the safety and security critical to keep work going smoothly.



1 ISO - conforming cabin with enhanced sturdiness for safety and dependability.

The cabin's use of extra-strength, extra-sturdy ROPS protects the operator in the event of a roll-over. It also conforms to the OPG Level 1 standard for structures protecting the operator from falling objects. This sturdy cabin lets you work in comfort and confidence.

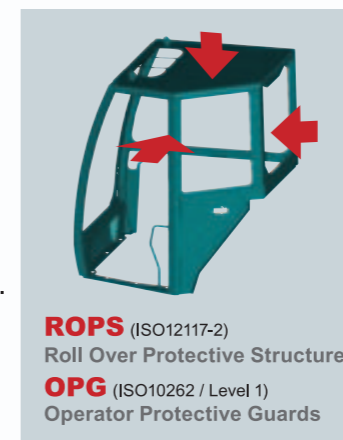

ROPS (ISO12117-2)
Roll Over Protective Structure
OPG (ISO10262 / Level 1)
Operator Protective Guards

2 Front guard / head guard brackets are standard equipment.

Users can easily attach a front guard and head guard by bolting them on, thus increasing protection of the operator.



3 Iron plate hood is highly durable, makes damage repair easy.

4 Underside protector has a thicker cover for greater strength.

5 Standard back and side mirrors let operator check for safety around and behind machine and keep others safe.

6 Track frame provides handy anchor holes for secure machine transportation.



Lock lever includes engine neutral start mechanism to prevent danger of accidental operation.

The engine will not start unless the lock lever is completely locked, which prevents equipment from moving suddenly if the lever is accidentally operated when the engine is started.

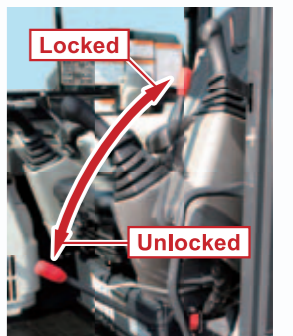

The travelling alarm warns others the machine is moving.



Large steps for getting on and off

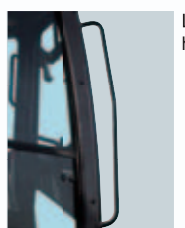

Large hand grips

EASY MAINTENANCE

Quicker checks and enhanced durability make troublesome maintenance a thing of the past.

Simple maintenance structure for fast and easy access wherever it's needed.

Covers open easily without any special tools, enabling fast and smooth checks and minimizing maintenance and cleaning times.

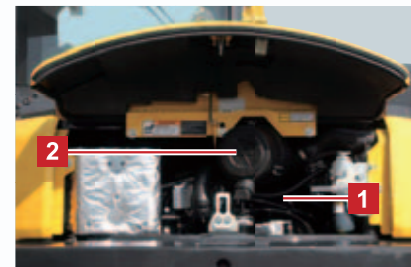
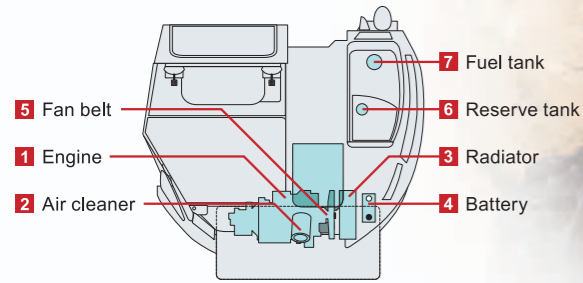

The wide-opening rear hood opens without special tools for easy checks and maintenance of the engine area and air cleaner.



Easy to adjust the fan belt and air conditioning belt.

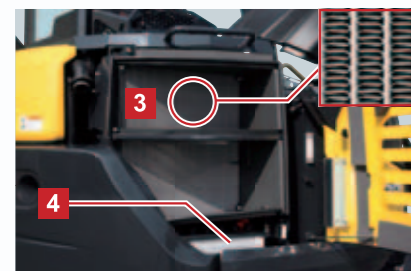

The right hood similarly opens wide and without tools to facilitate battery checks. It's also easy to clean the radiator, which is a wave fin style that resists clogging.

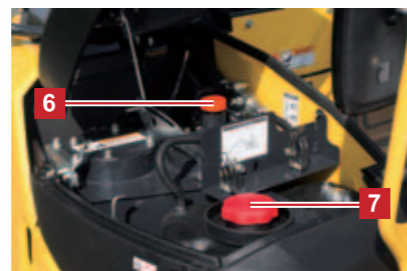

Open the cover on the upper right to fill the fuel tank, access the reserve tank and easily clean the back of the radiator.

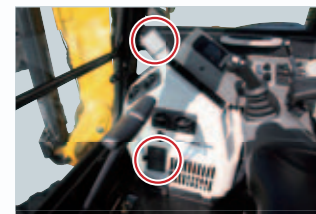

Air conditioning filters inside the cab removes easily without tools for easy cleaning and replacement.



Cab floor mats with high ends keep dust from getting under the mats and are easily washed with water.

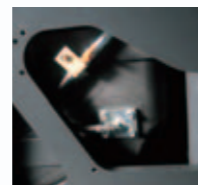

The bottom of the fuel tank has a flange for easy cleaning.

Maintenance-free hydraulic oil-lubricated reduction gear.



Ridged crawler frame easily sheds soil, reducing cleanup time and effort.

Dimensions

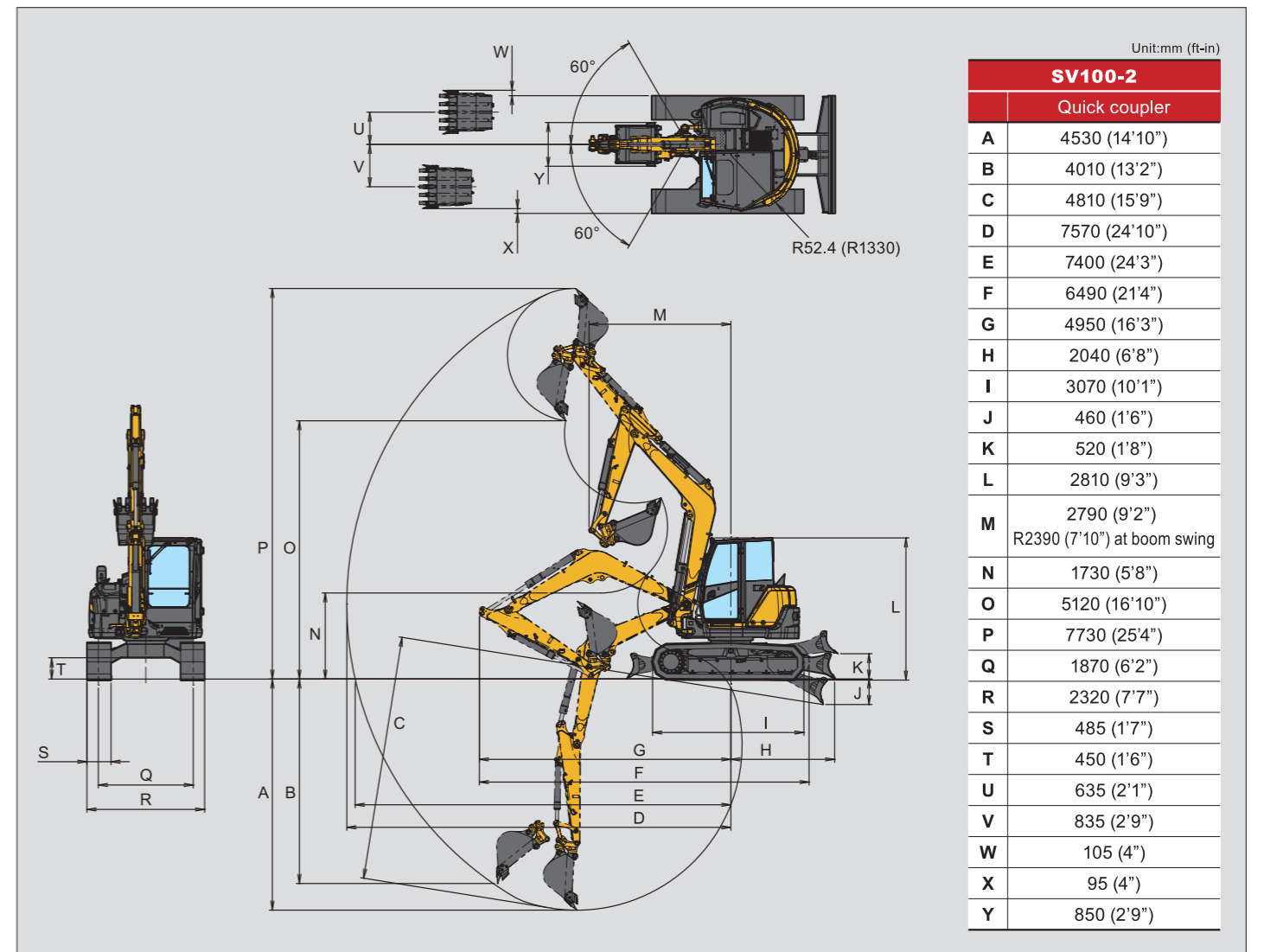

Specifications

Model		SV100-2	
Type		Cab. rubber track	Cab. steel track
Operating weight		lbs (kg)	21550 (9775) / 21660 (9825)
Engine	Type	Vertical four cylinder water-cooled direct injection diesel engine	
	Model	4TNV98T-ZSBV2	
	Rated output	HP (kW) / rpm	73.3 (54.7) / 2200
Performance	Maximum digging force (bucket) / arm	lbs. (kN)	12216 (54.3) / 4500 (42.3)
	Travel speed: high / low	MPH (km / h)	2.7 (4.4) / 1.6 (2.5) / 2.5 (4.0) / 1.4 (2.2)
	Swing speed	rpm	9.1
	Boom swing angle : left / right	degrees	60 / 60
	Gradability	degrees	30
Ground contact pressure		PSI (kPa)	5.5 (37.9) / 5.6 (38.8)
Hydraulic system	Hydraulic pump displacement	GPM (L / min)	20.5 (77.7) X2 <Variable displacement pump> / 15.2 (57.5) X1, 5.3 (20) X1 <Gear pump>
	System relief set pressure	PSI (MPa)	3988X2, 3481X1, 421X1 (27.5X2, 24.0X1, 2.9X1)
Blade dimensions	Width	mm (ft-in)	2320(7'7")
	Stroke,raise / lower from G.L.	mm (ft-in)	520 (1'8") / 460 (1'6") / 495 (1'7") / 485 (1'7")
Fuel tank capacity			115

Hydraulic PTO

Model	Output	SV100-2	
		PSI (kPa)	GPM (L / min)
Specification			2100RPM / 1200RPM
	Combined flow, double actions	3988 (27.5)	34.3 (130) / 19.8 (75)