

# SUMITOMO

## SH235X-6

### MINIMUM SWING RADIUS

- Engine Rated Power (Net): 119.3 kW·162.2 PS
- Operating Weight:
  - SH235X-6.....25,000-25,500 kg
- Bucket: ISO/SAE/PCSA Heaped: 0.50-1.10 m<sup>3</sup>

# SUMITOMO



**SUMITOMO (S.H.I.)  
CONSTRUCTION MACHINERY CO., LTD.**

731-1 Naganumahara-cho, Inage-ku, Chiba, 263-0001 Japan  
For further information please contact: Phone : +81-43-420-1829 Facsimile : +81-43-420-1907

We are constantly improving our products and therefore reserve the right to change designs and specifications without notice.  
Illustrations may include optional equipment and accessories and may not include all standard equipment.



# Performance Refined. Evolution Defined.

## Engine and Hydraulics 04-07

- New Generation Engine System "SPACE 5+"
- New Hydraulic System "SIH:S+"
- SUMITOMO Fuel Efficiency Technology
- Dramatically Increased Productivity

## Durability and Maintenance 08-09

- High Rigidity Attachments
- EMS
- Ground Level Maintenance

## Safety and Operator Comfort 10-13

- ROPS Cabin
- Stylish and Spacious Cabin
- High-Definition Full Colour LCD Monitor

## Specifications 14-19

### MADE IN JAPAN

The world knows that Japanese designed, engineered and manufactured products represent the highest quality, especially for Industrial Products. The hydraulic excavator is no exception when a totally intergrated concept is required in design work involving key components, manufacturing engineering, and product quality assurance in the factory. Sumitomo is one of the largest business groups in Japan, tracing its roots back to the late 1600's when they started a mining and copper smelting business, and since then have expanded and diversified their business operations on a continuing basis. Sumitomo hydraulic excavators are designed and manufactured today to meet the global demands of our many customers with the concept of Performance, Reliability, and Fuel Efficiency foremost in our minds. This proven Japanese technology and quality gives SUMITOMO excavator customers total peace of mind and provide a complete solution for the demands of the construction industry.



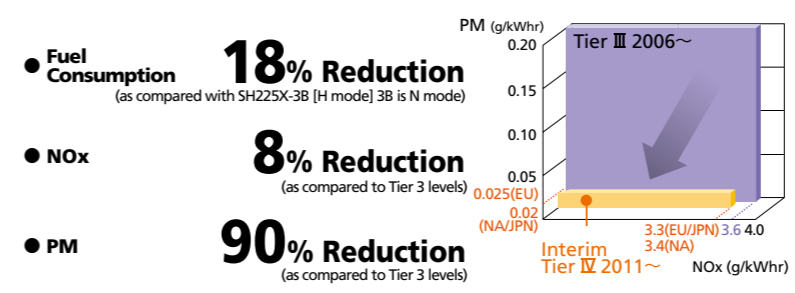

**Compliant to Emission Regulations U.S. EPA Tier 4 Interim, EU Stage III B, and JPN Tier 4 Interim**

The state-of-the-art engine system "SPACE 5+" substantially reduces NOx (nitrogen oxide) and PM (particulate matter) contained in the exhaust gas, further reducing or minimising the impact on the environment.

**New Generation Engine System "SPACE 5+"**

The new engine system optimises fuel efficiency and environmental performance via the advanced common rail fuel injection system, cooled EGR system, and VG (variable geometry) turbocharger. At the same time, excellent response times are achieved.

**4HK1X Engine System Overview**

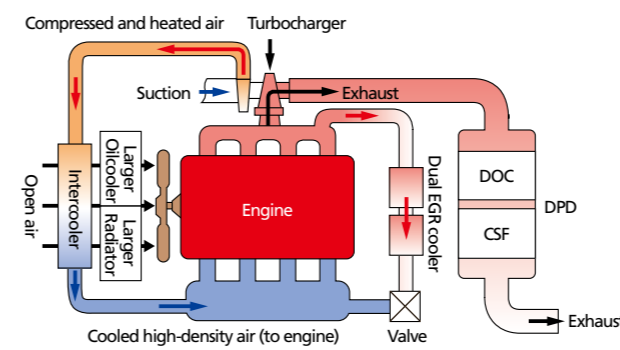

**After-Treatment Technology: Diesel Particulate Diffuser (DPD)**

DPD is an exhaust after-treatment device which traps and burns off PM in the exhaust gas. PM accumulation can be monitored by the DPD status gauge, and Auto Regeneration (filter cleaning) will be conducted at regular intervals.

**DPD Structural Overview**

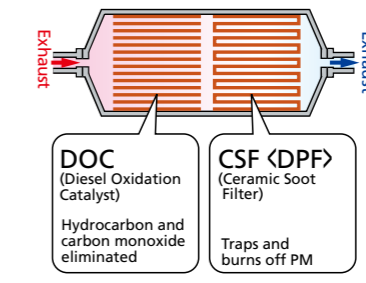

**Monitor Display (DPD gauge)**

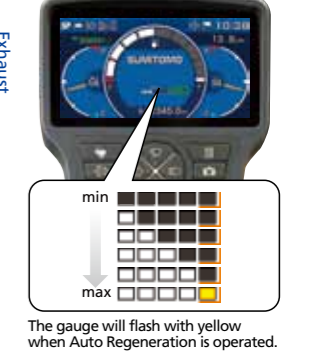

**Mode Selection by Throttle**

There are three new working modes available: SP (Super Power) for heavy duty applications, H (Heavy) for normal working conditions, and A (Auto) for a wide range of operations.



**SUMITOMO Technology for Fuel Efficiency**

- **SSC (Spool Stroke Control)** SUMITOMO UNIQUE DESIGN  
Reduces engine load upon heavy duty operation.
- **PTR (Pump Transition Reduction)** SUMITOMO UNIQUE DESIGN  
Decreases engine load when the pump flow requirement is reduced upon abrupt pump load.
- **BES (Boom-down Energy Save)** SUMITOMO UNIQUE DESIGN  
Lowers engine speed upon boom-down and swing operation which does not require large oil flow.
- **AES (Auto Energy Save)** SUMITOMO UNIQUE DESIGN  
Lowers engine speed accordingly when low engine load is sensed.

**Idle Shut Down & Auto Idle**

Upon activation, idle shut down automatically shuts the engine down when the machine is not in operation for set amount of time. Auto Idle is also available, which makes the engine begin idling approximately five seconds after the operation levers are in neutral position.



**Further Improvement of Fuel Consumption**

The new technology has improved operations and reduced fuel consumption on each working mode.

- **SP mode 10% reduction in fuel consumption**
- **H mode 18% reduction in fuel consumption**
- **A mode 8% reduction in fuel consumption**

(as compared with SH225X-3B. SP mode and H mode has been compared with N mode, and A mode with E mode)  
\* Fuel consumption may vary from time to time depending on site and working conditions, operator skill and other circumstances.

**Engine and Hydraulics**

SH235X-6 has achieved a 18% reduction in fuel consumption in comparison with our DASH 3B series, by fusing the new generation engine system "SPACE 5+" and the new hydraulic system "SIH:S+", further refining fuel efficiency. At the same time the newly developed ISUZU engine, which complies with emission regulations such as U.S. EPA Tier 4 Interim and EU Stage III B, contributes greatly to the environment.



New Engine System **SPACE 5+ PLUS** + New Hydraulic System **SIH:S+ PLUS** = **18% Reduction in Fuel Consumption**  
(in H mode as compared with SH225X-3B [N mode])





## Engine and Hydraulics

SUMITOMO's original Spool Stroke Control (SSC) technology perfectly matches the engine and hydraulic power, and further improves the operational speed whilst maintaining smooth control of the machine.

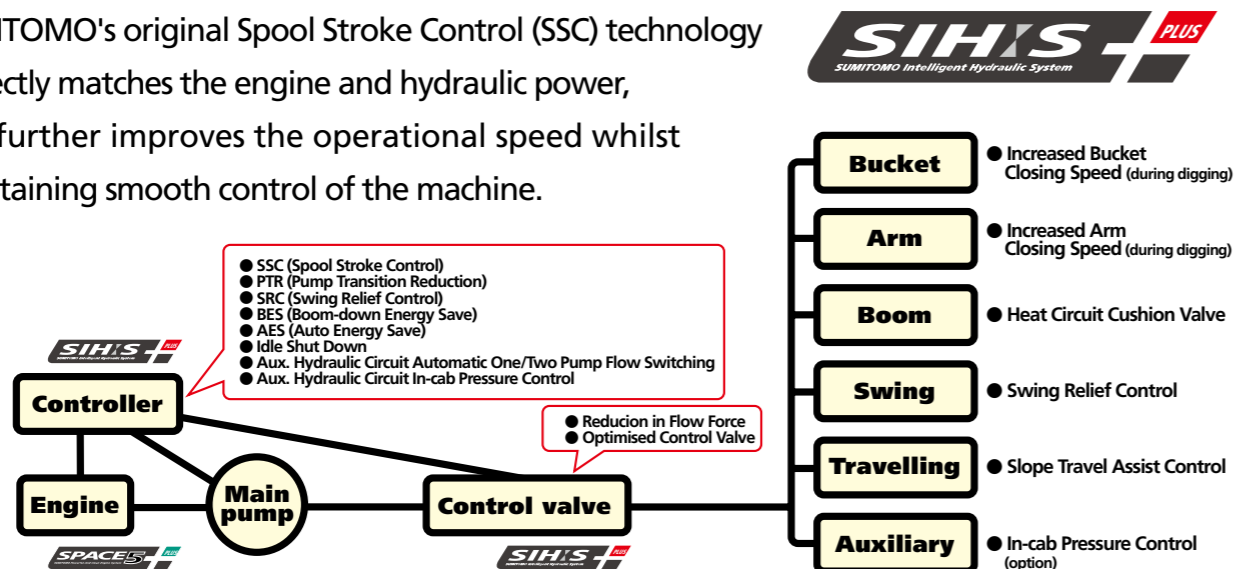

### Small Rear Swing Suited to a Diverse Range of Jobs

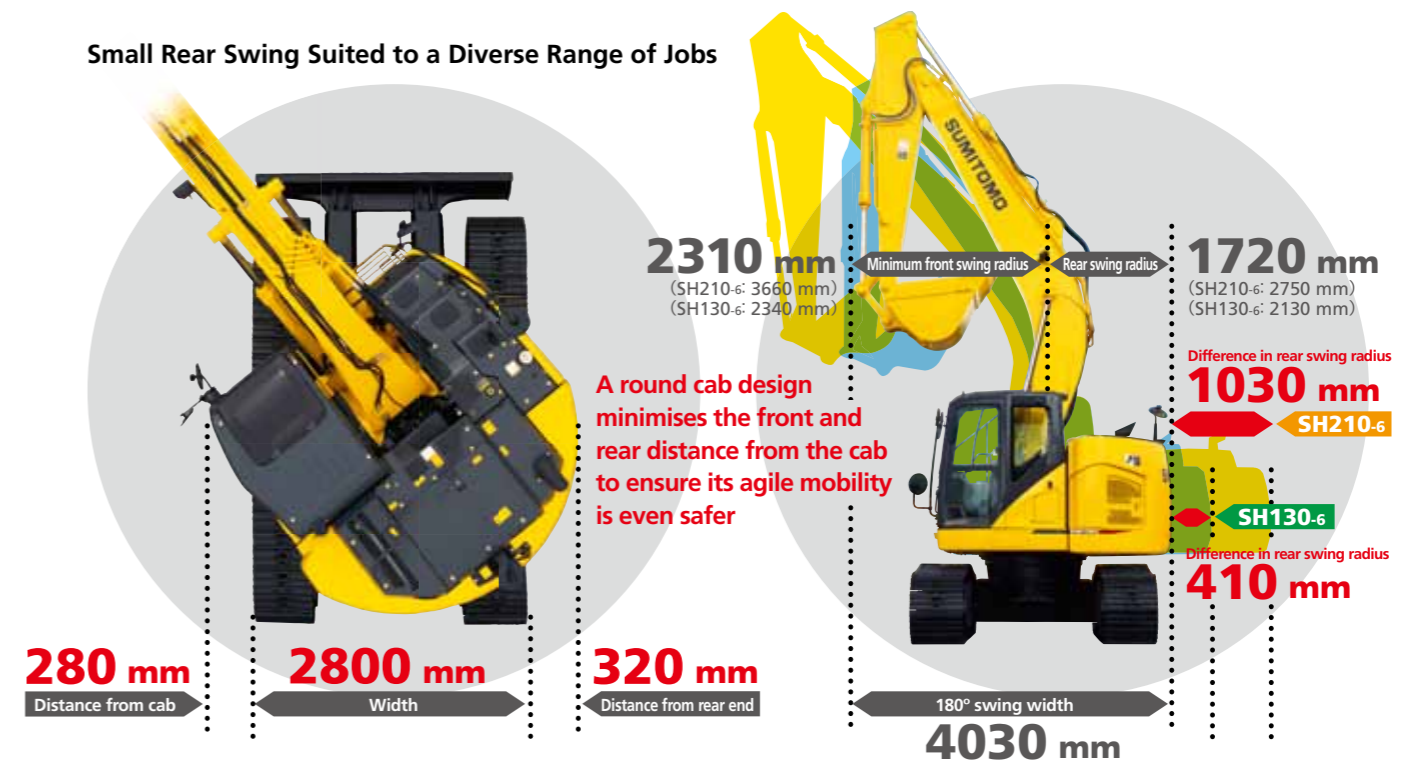

Note: The figures shown above are achieved when standard counterweights are installed. The minimum rear swing will differ to these figures when heavier counterweights are installed.

### Work Efficiency Drastically Increased **SUMITOMO UNIQUE DESIGN**

Spool Stroke Control (SSC) variably controls spool port flow rate, depending on the condition of operation. Improved power, speed, and smoother controls mean that work efficiency is dramatically increased.

### 8% Faster Cycle Time (SP mode)

Speed increase by 8% in cycle time has been achieved, giving further advance in productivity (as compared with SH225X-3B [N mode]).

### Real Digging Power

The true digging force can not be expressed by a maximum digging power figure listed in sales brochures. With an improved hydraulic system and a large arm cylinder, the arm-in motion speed slowdown is minimised. The digging power when combined with the attachment speed in motion convert to the operator's "Real Digging Power".

### Speed and Power, Dramatically Increases Productivity

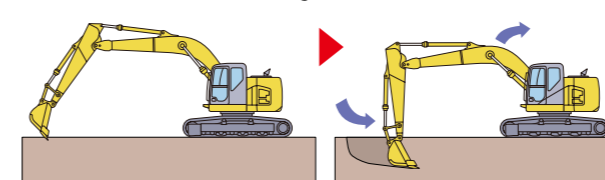

- SP mode **8% faster cycle time**
- H mode **4% faster cycle time**
- A mode **9% faster cycle time**

(as compared with SH225X-3B. SP mode and H mode has been compared with N mode, and A mode with E mode) \* Based on SUMITOMO's testing condition and results.

### Remarkable Combined Operation

Prevents rapid deceleration upon combined operation such as attachment operation when travelling, ensuring stable performance.

### Auxiliary Hydraulic Circuit

Selection of auxiliary circuit has been made easier. Correct pump flow (one pump or two pump) will automatically be activated upon operator's selection of the circuit. In-cab pressure control (option) also available.

### Automatic Power Boost

The digging power increases automatically in quick response to the working conditions during heavy-duty digging work. This is a design unique to SUMITOMO, and continues for eight seconds (SPH mode).

### Operating Condition Easily Viewable on Display

Various control such as working modes and auxiliary hydraulic setting can be easily selected by the universally designed switch panel, and the selected mode can be easily viewed on the 7" wide monitor.





# Durability and Maintenance

Serviceability and durability are also important points of machine performance. Ground level access to the engine area makes daily maintenance extremely straightforward. Reliability has been further enhanced by increasing cooling capability and durability.



## EMS (Easy Maintenance System) as Standard

SUMITOMO's EMS keeps the pins and bushes fully lubricated at all times and prevents rattling. This system significantly extends the service life of the pins and bushes.

The lubrication interval around the bucket is 250 hours, and for the other sections is 1,000 hours, keeping the joints lubricated for a long time and extending the service life of parts by reducing abrasion and rattling.

- ➡ Sections equipped with steel EMS bushing
- ➡ Sections equipped with EMS bushing

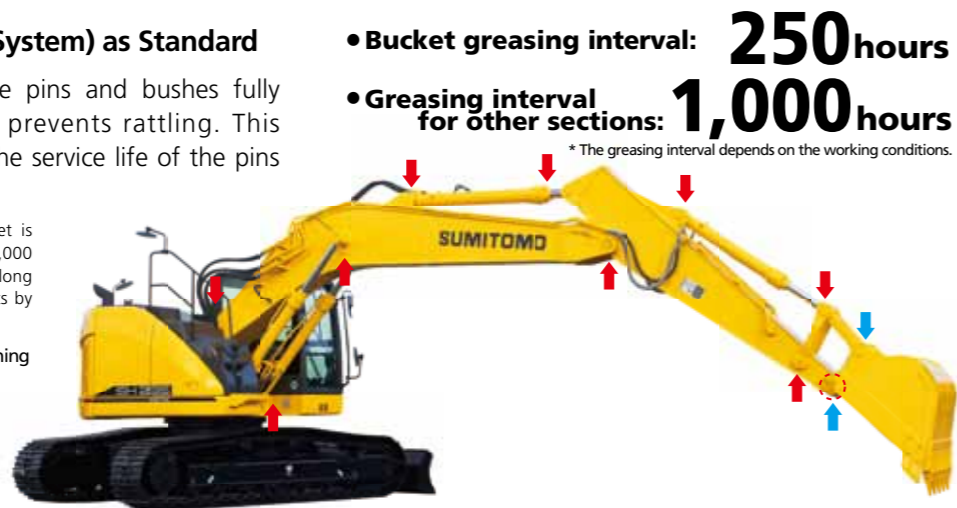

- **Bucket greasing interval: 250 hours**
  - **Greasing interval for other sections: 1,000 hours**
- \* The greasing interval depends on the working conditions.

## EMS bushing

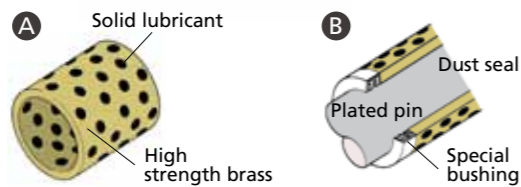

- ➡ A solid lubricant embedded in high strength brass forms a layer on the bushing surface to prevent contact between metals, maintaining an excellent lubricated state to reduce abrasion of joints.
- ➡ The surface of the pin is plated to increase the surface hardness and improve the wear resistance accordingly.

## Steel EMS bushing



Steel EMS is installed around the bucket

## Precautionary use of EMS

- ① Grease is enclosed, however greasing is necessary every 1000 hours or six months depending on the level of dusting conditions.
- ② Greasing is also necessary after any components have been submerged underwater for prolonged periods.
- ③ Greasing is also recommended after use with hydraulic breakers, crushers or other high impact attachments such as rock saws.
- ④ Bucket pins should be cleaned thoroughly when removing or attaching new buckets.

## High Rigidity Attachments

The structure of the boom and arm has been further improved, ensuring strength and durability. In addition, high strength castings are used for the boom base and arm end, improving reliability.

### Boom

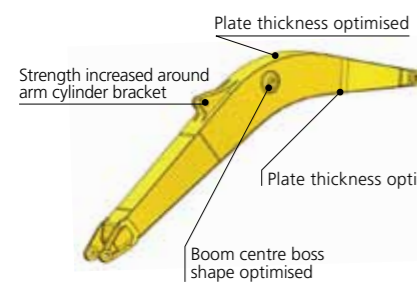

### Arm

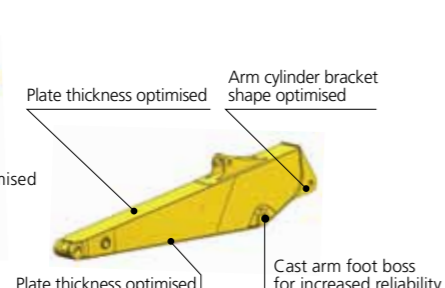

## High Rigidity Undercarriage

For improved mobility, the track system has been strengthened ensuring longer wear life, performance, and improved reliability.

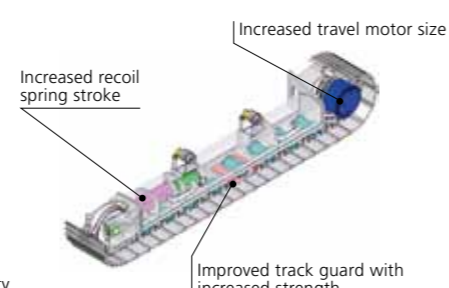

## Ground Level Access to Engine Area Improves Preventative Maintenance

Parts cleaning and maintenance are possible from the ground without climbing onto the upper structure of the excavator body.

### ● Increased Cooling Capability

With the larger radiator and oil cooler, cooling capacity is increased, thus improving reliability. In addition, cleaning of the dust-proof net is simplified.

### ● Easy Filter Replacement

A fuel prefilter and clogging sensor to the main fuel filter are provided as standard equipment to reduce trouble due to fuel clogging. In addition, the fuel and oil filters are installed at ground-accessible location to facilitate replacement.

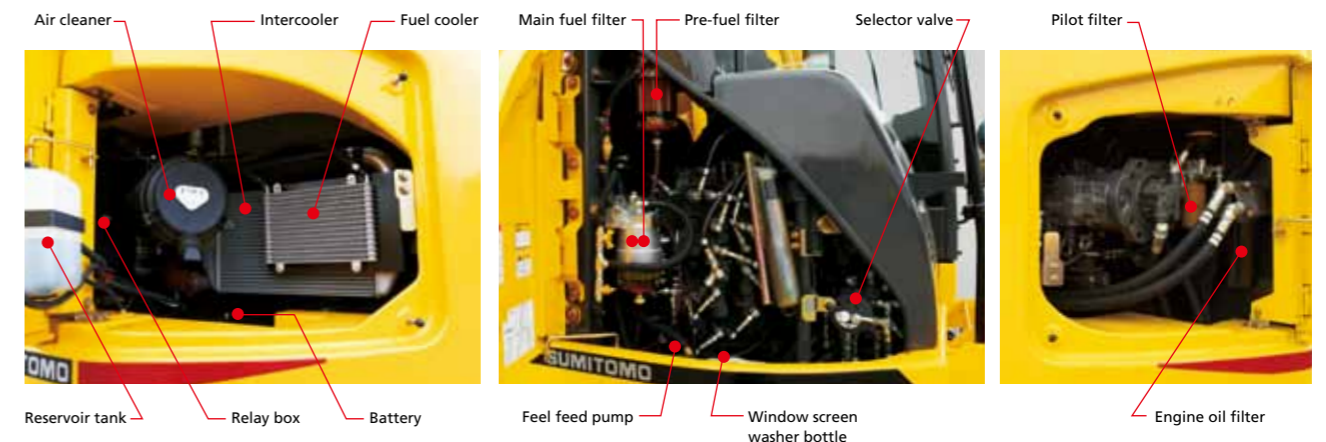

## High-Performance Return Filter

The hydraulic oil change interval is 5,000 hours, and the return filter change interval is 2,000 hours. One high performance return filter keeps the same level of filtering as a nephron.



- **Hydraulic oil change: 5,000 hours**

- **Life of filter: 2,000 hours**

\* The oil and filter change interval varies depending on the working conditions.

## Cab Floor Mat

**SUMITOMO**  
UNIQUE DESIGN

The washable floor mat has been redesigned for ease of removing and cleaning.

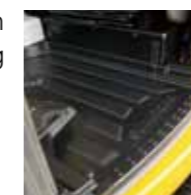

## Easy Access to A/C Filter

The air intake filter is located in a lockable compartment to make it easier to replace, and access to the inside cab filter has been simplified.



## Fuse Box Location

The fuse box has been located in a separate compartment behind the seat, allowing easier access.

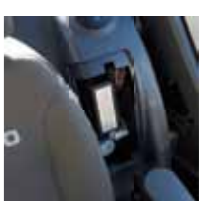





## Safety and Operator Comfort

The cabin provides Roll Over Protective Structure (ROPS) in compliance with ISO 12117-2:2008. This enhanced protection comes standard from the factory.

The cabin is also compliant to OPG Top Guard Level 1.

To support the operator in the field, the DASH 6 incorporates a 7" wide full colour LCD monitor with numerous functions and universally designed switch panel.

The ROPS compliant cabin with enhanced operator comfort ensures a safe working environment.

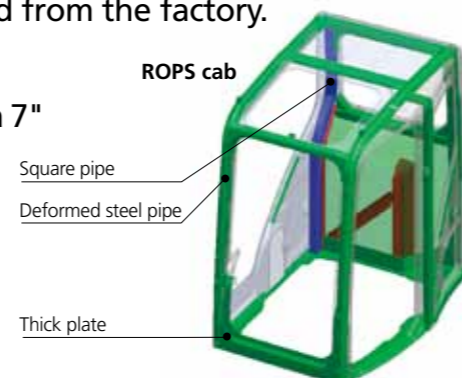

### Wide View Increases Safety of Work

In addition to the wide front view, the upper view has been widened to enhance work safety.

### Rearview Camera

With the standard rearview camera, the operator can view the image on the large LCD monitor. A side camera is available as an optional extra and up to two different images can be displayed on the monitor.



Side camera (option)



Rearview camera (standard)

### Safe and Easy Entry into and Exit from the Cab

A large handrail for easy opening/closing of the door and increased floor space permit the operator to get in and out of the cab easily.



### Easy Access to the Upper Structure



New larger front-right step



ISO-compliant large handrail



Non-slip plate

### New OPG Level 2 Head Guard

OPG Level 2 head guard is available as an option. The see-through grille has been redesigned for better protection and visibility.



### ISO Compliant Rearview Mirror

The new ISO compliant rearview mirrors reduce blind spots during operation. Together with the front mirrors, visibility is secured for safe operation.



Front/Side mirror



Rearview mirrors

### Safety Equipment



Anti-theft alarm system



Immobiliser (option)



Emergency stop switch





### Large High-Definition LCD Monitor

A new large high-definition full colour LCD monitor has been introduced with better visibility and a switch panel which is easy to operate. Added functionality such as ECO gauge showing parameter of energy saving, display of operation status and warning messages, provides accurate information which improves work efficiency and safety.

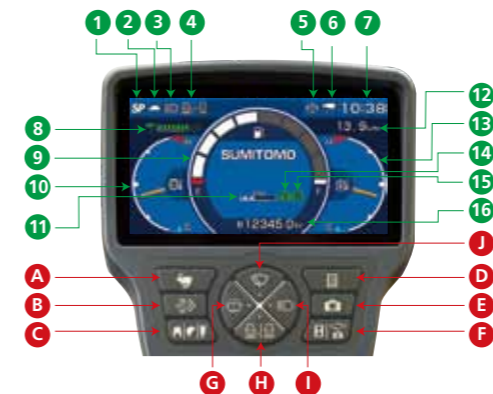

#### Indicators

- 1 Working modes
- 2 Travel speed
- 3 Work lights
- 4 Engine idle modes
- 5 Free swing / Anti-theft
- 6 Attachment selection
- 7 Digital clock
- 8 ECO gauge
- 9 Fuel level gauge
- 10 Engine coolant temperature
- 11 DPD status gauge
- 12 Fuel consumption indicator
- 13 Hydraulic oil temperature
- 14 Power boost
- 15 Radio mute
- 16 Hour meter

#### Switch Panel

- A Travel speed button
- B Manual regen button
- C Aux. hydraulics settings
- D Computer menu
- E Camera on/off
- F Hour meter / Camera toggle button
- G Window washer control
- H Engine idle mode button
- I Worklights on/off
- J Window wiper control

### Super Comfortable Cab Mounts and Pressurised Cab

Fluid mounts that support the cab absorb shocks and vibrations effectively, improving ride comfort. The cab also features a pressurised design to prevent dust from entering inside, giving operators greater comfort.

#### Fluid mount

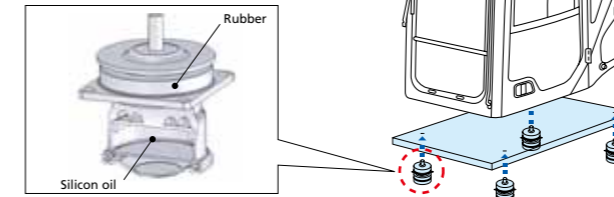

### Automatic Air Conditioner

An automatic air conditioner is included to keep the cab interior at the ideal temperature. The sealed, pressurised cab helps to increase air conditioner efficiency.



Operating panel

### Radio and Speaker with MP3 Jack

In addition to the AM/FM radio and dual speaker system with improved sound quality, auxiliary audio port is provided standard for devices such as MP3 players.



Operating panel

### Ample Legroom and Comfortable Seats

Legroom around the cab has been increased for comfortable operations. The operator seat features a head rest and arm rests, and comes with a wide range of seat adjustment functions with a comfortable suspension system.



Air suspension seat (option)

### Roof Window for Greater Freedom

A new pop-up roof window (made of polycarbonate) with sun shade has been installed for greater comfort.



### Under-cab Storage Space

Storage space has been included under the cab for various tools.



### Comfortable Equipment

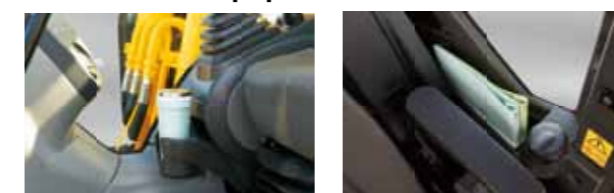

Cup holder

Magazine rack

## Safety and Operator Comfort

The spacious cab on fluid mounts and reclining suspension seat help reduce operator fatigue and provide a relaxed environment.





# Specifications

## SH235X-6 Technical Data

Electronic-controlled engine of SPACE 5+ and SIH:S+ with New Hydraulic System Includes: three working modes (SP,H,A) one-touch/automatic idling system, automatic power-boost, speed assistance system, power-swing system.

### Engine

SH235X-6	
Model	ISUZU AL-4HK1X
Type	Water-cooled, 4-cycle diesel, 4-cylinder in line, high pressure common rail system (electric control), turbocharger with air cooled intercooler, DPD system.
Rated output	119.3 kW / 1,800 min <sup>-1</sup>
Maximum torque	621 N·m at 1,500 min <sup>-1</sup>
Piston displacement	5.193 ltr
Bore and stroke	115 mm x 125 mm
Starting system	24 V electric motor starting
Alternator	24 V, 50 A
Fuel tank	320 ltr
Air filter	Double element

### Hydraulic pumps

Two variable displacement axial piston pumps provide power for boom/arm/bucket, swing, and travel. One gear pump for pilot controls.

SH235X-6	
Maximum oil flow	2 x 211 ltr/min
Pilot pump max.oil flow	18 ltr/min

### Hydraulic motors

For travel: Two variable displacement axial piston motors.  
For swing: One fixed displacement axial piston motor.

### Relief valve settings

Boom/arm/bucket .....34.3 MPa (350 kgf/cm<sup>2</sup>)  
Boom/arm/bucket .....36.8 MPa (380 kgf/cm<sup>2</sup>) with auto power-up  
Swing circuit .....29.4 MPa (300 kgf/cm<sup>2</sup>)  
Travel circuit .....34.3 MPa (350 kgf/cm<sup>2</sup>)

### Control valve

With boom/arm holding valve  
One 4-spool valve for right track travel, bucket, boom and arm acceleration  
One 5-spool valve for left track travel, auxiliary, swing, boom acceleration and arm  
One 1-spool valve for blade

### Oil filtration

Return filter ..... 6 microns  
Pilot filter ..... 8 microns  
Suction filter ..... 105 microns

### Hydraulic cylinders

Cylinder	Q'ty	Bore x Rod Diameter x Stroke
Boom	2	120 mm x 85 mm x 1370 mm
Arm	1	140 mm x 100 mm x 1460 mm
Bucket	1	120 mm x 85 mm x 1010 mm
Blade	2	130 mm x 80 mm x 260 mm

Double-acting, bolt-up type cylinder tube-end; hardened steel bushings installed in cylinder tube and rods ends.

### Cab & controls

Roll-over protective structure (ROPS) cab, top guard OPG level1 (in cab structure). Cab mounted on four fluid mountings. Features include safety glass front, rear and side windows, adjustable upholstered suspension seat with headrest and armrest, cigarette lighter, pop-up skylight window, and intermittent wiper with washer. Front window slides upward for storage and the lower front window is removable. Built-in type full-colour monitor display. Membrane switch on monitor display.

### Swing

Planetary reduction powered by axial piston motor. The internal ring gear with grease cavity for pinion. Swing bearing is single-row shear type ball bearing. Dual stage relief valves for smooth swing deceleration and stops. Mechanical disc swing brake.

SH235X-6	
Swing speed	0~11.8 rpm
Tail swing radius	1,720 mm
Swing torque	64.0 kN·m (6,526 kgf·m)

### Undercarriage

X-style carbody is integrally welded for strength and durability. Grease cylinder track adjusters with shock absorbing springs. Undercarriage with lubricated rollers and idlers.

### Type of shoe: sealed link shoe

#### Upper rollers -

Heat treated, mounted on steel bushings with leaded tin bronze casting, sealed for lifetime lubrication.

#### Lower rollers -

Heat treated, mounted on steel bushings with leaded tin bronze casting, sealed for lifetime lubrication.

#### Track adjustment -

Idler axles adjusted with grease cylinder integral with each side frame; adjustment yoke mechanism fitted with heavy duty recoil spring.

### Number of rollers and shoes on each side

SH235X-6	
Upper rollers	2
Lower rollers	7
Track shoes	46

### Travel system

Two-speed independent hydrostatic system with compact axial motors for increased performance. Hydraulic motor powered output shaft coupled to a planetary reduction unit and track sprocket. All hydraulic components mounted within the width of side frame. Travel speed can be selected by switch panel. Hydraulically released disc parking brake is built each motor.

SH235X-6		
Travel speed	High	5.0 km/h
	Low	3.2 km/h
Drawbar pull	201 kN (23,760kgf)	

### Lubricant & coolant capacity

SH235X-6	
Hydraulic system	252 ltr
Hydraulic oil tank	114 ltr
Fuel tank	320 ltr
Cooling system	30.9 ltr
Final drive case (per side)	5.0 ltr
Swing drive case	5.0 ltr
Engine crank case	23.1ltr

### Auxiliary hydraulic system

SH235X-6			
Auxiliary piping type (option)	For Breaker	For Double (breaker & crusher) acting	For D/A + Second option line
Arm type	STD	HD	HD
Bucket linkage type	HD	HD	HD
Auxiliary hydraulic pump flow	211 ltr/min	422 ltr/min	422+73 ltr/min

## Bucket

Model	SH235X-6											
Bucket capacity (ISO/SAE/PCSA heaped)	0.50 m <sup>3</sup>	0.80 m <sup>3</sup>		0.80 m <sup>3</sup>		0.90 m <sup>3</sup>		1.00 m <sup>3</sup>		1.10 m <sup>3</sup>		
Bucket capacity (CECE heaped)	0.45 m <sup>3</sup>	0.70 m <sup>3</sup>		0.70 m <sup>3</sup>		0.80 m <sup>3</sup>		0.90 m <sup>3</sup>		0.90 m <sup>3</sup>		
Bucket type	STD	STD	Level-pin	Hevy duty	Hevy duty Level-pin	Hevy duty Super-V	STD	Level-pin	STD	Level-pin	STD	
Number of teeth	3	5		5		5		6		6		
Width (mm)	With side cutter	830	1 130		1 136		1 230		1 360		1 460	
	Without side cutter	730	1 030		1 036		1 130		1 260		1 360	
Weight (kg)	2.40 m arm	523	654	639	730	726	736	694	674	747	729	780
	2.94 m arm	●	●	●	●	●	●	○	○	○	○	○
Combination	2.40 m arm	●	○	○	○	○	○	○	○	○	○	○
	2.94 m arm	●	○	○	○	○	○	○	○	○	○	○

○ Suitable for materials with density up to 2,000 kg/m<sup>3</sup> or less

○ Suitable for materials with density up to 1,600 kg/m<sup>3</sup> or less

● Standard bucket (suitable for materials with density up to 1,800 kg/m<sup>3</sup> or less)

## Weight & Ground Pressure

Model	SH235X-6			
Shoe type	Shoe width	Overall width	Operating weight	Ground pressure
Triple grouser shoe	600 mm	2 990 mm	25 000 kg	56 kPa
	700 mm	2 990 mm	25 200 kg	48 kPa
	800 mm	3 000 mm	25 500 kg	43 kPa

## Digging Force

Model	SH235X-6		
Arm length	2.40 m		2.94 m
Bucket digging force	ISO 6015	142 kN (152 kN)	142 kN (152 kN)
	SAE: PCSA	127 kN (136 kN)	127 kN (136 kN)
Arm digging force	ISO	123 kN (132 kN)	103 kN (110 kN)
	SAE: PCSA	119 kN (127 kN)	100 kN (107 kN)



## Lifting Capacity

Notes: 1. Ratings are based on ISO 10567

- Lifting capacity does not exceed 75% of tipping load with the machine on firm, level ground or 87% full hydraulic capacity.
- The load point is a hook (not standard equipment) located on the back of the bucket.
- \*Indicates load limited by hydraulic capacity.
- 0 m = Ground.

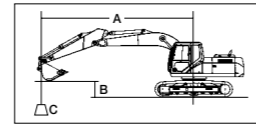

A: Radius of load  
B: Bucket hook height  
C: Lifting capacity

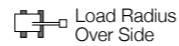

Unit: kg

### SH235X-6

SHOE : 600 (mm)G  
BUCKET : SAE/PCSA 0.9 (m<sup>3</sup>)  
ARM LENGTH : 2.40 (m)  
MAXIMUM REACH : 9.37 (m)  
BOOM : 6.15 (m)

Bucket Hook Height	Max. Radius		9 m		7.5 m		6 m		4.5 m		3 m		1.5 m		Min. Radius			
	(kg)	(m)	(kg)	(m)	(kg)	(m)	(kg)	(m)	(kg)	(m)	(kg)	(m)	(kg)	(m)	(kg)	(m)		
9 m	3 800*	5.32	3 800*	5.32					3 540*	3 540*			2 160*	4.14	2 160*	4.14		
7.5 m	3 320*	7.08	3 320*	7.08			4 450*	4 450*	3 670*	3 670*			3 560*	4.31	3 560*	4.31		
6 m	3 160*	8.12	2 900	8.12		4 510*	3 390	4 990*	4 900	5 210*	5 210*			5 320*	3.95	5 320*	3.95	
4.5 m	3 140*	8.72	2 490	8.72		5 000*	3 300	5 530*	4 810	6 690*	6 690*	8 450*	8 450*	8 050*	1.74	8 050*	1.74	
3 m	3 230*	9	2 290	9	3 240*	2 290	5 370*	3 170	6 460*	4 550	8 580*	7 140	10 170*	10 170*	6 350*	2.97	6 350*	2.97
1.5 m	3 430*	9	2 240	9		5 790*	3 040	7 250*	4 310	9 980*	6 620			6 160*	3.16	6 160*	3.16	
0 m	3 780*	8.72	2 330	8.72		5 970*	2 940	7 660*	4 130	10 570*	6 330	7 730*	7 730*	5 740*	2.57	5 740*	2.57	
-1.5 m	4 400*	8.16	2 590	8.16		5 860*	2 930	7 640*	4 080	10 450*	6 310	11 350*	11 350*	8 070*	0.93	5 570*	0.93	
-3 m	5 140*	7.25	3 140	7.25			7 120*	4 170	9 700*	6 420	13 840*	12 620	11 320*	11 320*	9 780*	0.92	9 780*	0.92
-4.5 m	5 070*	5.87	4 430	5.87					7 800*	6 620	10 950*	10 950*			15 330*	1.77	15 330*	1.77

### SH235X-6

SHOE : 600 (mm)G  
BUCKET : SAE/PCSA 0.9 (m<sup>3</sup>)  
ARM LENGTH : 2.40 (m)  
MAXIMUM REACH : 9.37 (m)  
BOOM : 6.15 (m)

Bucket Hook Height	Max. Radius		9 m		7.5 m		6 m		4.5 m		3 m		1.5 m		Min. Radius			
	(kg)	(m)	(kg)	(m)	(kg)	(m)	(kg)	(m)	(kg)	(m)	(kg)	(m)	(kg)	(m)	(kg)	(m)		
9 m	3 800*	5.32	3 800*	5.32					3 540*	3 540*			2 160*	4.14	2 160*	4.14		
7.5 m	3 320*	7.08	3 320*	7.08			4 450*	4 450*	3 670*	3 670*			3 560*	4.31	3 560*	4.31		
6 m	3 160*	8.12	2 760	8.12		4 510*	3 230	4 990*	4 730	5 210*	5 210*			5 320*	3.95	5 320*	3.95	
4.5 m	3 140*	8.72	2 360	8.72		4 780	3 140	5 530*	4 590	6 690*	6 690*	8 450*	8 450*	8 050*	1.74	8 050*	1.74	
3 m	3 230*	9	2 170	9	3 240*	2 170	4 650	3 020	6 460*	4 340	8 580*	6 790	10 170*	10 170*	6 350*	2.97	6 350*	2.97
1.5 m	3 360	9	2 120	9		4 510	2 890	6 420	4 100	9 980*	6 280			6 160*	3.16	6 160*	3.16	
0 m	3 500	8.72	2 210	8.72		4 400	2 790	6 220	3 920	9 890	5 990	7 730*	7 730*	5 740*	2.57	5 740*	2.57	
-1.5 m	3 870	8.16	2 450	8.16		4 390	2 780	6 160	3 870	9 850	5 970	11 350*	11 240	8 070*	0.93	5 570*	0.93	
-3 m	4 680	7.25	2 980	7.25			6 240	3 960	9 700*	6 090	13 840*	11 930	11 320*	11 320*	9 780*	0.92	9 780*	0.92
-4.5 m	5 070*	5.87	4 210	5.87					7 800*	6 320	10 950*	10 950*			15 330*	1.77	15 330*	1.77

### SH235X-6

SHOE : 600 (mm)G  
BUCKET : SAE/PCSA 0.8 (m<sup>3</sup>)  
ARM LENGTH : 2.94 (m)  
MAXIMUM REACH : 9.85 (m)  
BOOM : 6.15 (m)

Bucket Hook Height	Max. Radius		9 m		7.5 m		6 m		4.5 m		3 m		1.5 m		Min. Radius			
	(kg)	(m)	(kg)	(m)	(kg)	(m)	(kg)	(m)	(kg)	(m)	(kg)	(m)	(kg)	(m)	(kg)	(m)		
9 m	2 490*	6.26	2 490*	6.26			3 120*	3 120*							2 030*	4.5	2 030*	4.5
7.5 m	2 210*	7.76	2 210*	7.76			2 990*	2 990*	4 010*	4 010*					3 200*	4.9	3 200*	4.9
6 m	2 120*	8.69	2 120*	8.69			4 070*	3 460	4 420*	4 420*					4 410*	4.61	4 410*	4.61
4.5 m	2 110*	9.24	2 110*	9.24	3 070*	2 390	4 610*	3 360	5 090*	4 880	5 790*	5 790*	5 040*	5 040*	4 770*	2.9	4 770*	2.9
3 m	2 180*	9.49	2 090	9.49	4 060*	2 330	5 120*	3 230	6 110*	4 670	7 920*	7 300*	10 690*	10 690*	7 430*	2.09	7 430*	2.09
1.5 m	2 330*	9.48	2 050	9.48	4 460*	2 260	5 630*	3 090	6 990*	4 400	9 610*	6 820	9 690*	9 690*	3 970*	2.35	3 970*	2.35
0 m	2 570*	9.22	2 120	9.22	3 850*	2 210	5 920*	2 970	7 560*	4 190	10 480*	6 430	8 650*	8 650*	3 750*	1.45	3 750*	1.45
-1.5 m	2 990*	8.69	2 330	8.69		5 940*	2 910	7 670*	4 070	10 540*	6 290	10 810*	10 810*	7 000*	0.27	5 130*	0.27	
-3 m	3 900*	7.86	2 730	7.86		5 570*	2 980	7 430*	4 110	10 130*	6 360	14 600*	12 560	9 670*	0.27	7 790*	0.27	
-4.5 m	5 100*	6.7	3 560	6.7			6 320*	4 330	8 810*	6 560	12 630*	12 500	14 040*	14 040*	12 060*	0.93	12 060*	0.93
-6 m	5 280*	4.61	5 280*	4.61					5 500*	5 500*					7 590*	3.36	7 590*	3.36

Notes: 1. Ratings are based on ISO 10567

- Lifting capacity does not exceed 75% of tipping load with the machine on firm, level ground or 87% full hydraulic capacity.
- The load point is a hook (not standard equipment) located on the back of the bucket.
- \*Indicates load limited by hydraulic capacity.
- 0 m = Ground.

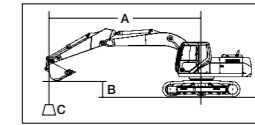

A: Radius of load  
B: Bucket hook height  
C: Lifting capacity

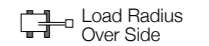

Unit: kg

### SH235X-6

SHOE : 600 (mm)G  
BUCKET : SAE/PCSA 0.8 (m<sup>3</sup>)  
ARM LENGTH : 2.94 (m)  
MAXIMUM REACH : 9.85 (m)  
BOOM : 6.15 (m)

Bucket Hook Height	Max. Radius		9 m		7.5 m		6 m		4.5 m		3 m		1.5 m		Min. Radius			
	(kg)	(m)	(kg)	(m)	(kg)	(m)	(kg)	(m)	(kg)	(m)	(kg)	(m)	(kg)	(m)	(kg)	(m)		
9 m	2 490*	6.26	2 490*	6.26											2 030*	4.5	2 030*	4.5
7.5 m	2 210*	7.76	2 210*	7.76			2 990*	2 990*	4 010*	4 010*					3 200*	4.9	3 200*	4.9
6 m	2 120*	8.69	2 120*	8.69			4 070*	3 310	4 420*	4 420*					4 410*	4.61	4 410*	4.61
4.5 m	2 110*	9.24	2 110*	9.24	3 070*	2 270	4 610*	3 200	5 090*	4 700	5 790*	5 790*	5 040*	5 040*	4 770*	2.9	4 770*	2.9
3 m	2 180*	9.49	1 980	9.49	3 450	2 210	4 710	3 070	6 110*	4 460	7 920*	7 030	10 690*	10 690*	7 430*	2.09	7 430*	2.09
1.5 m	2 330*	9.48	1 940	9.48	3 380	2 140	4 560	2 940	6 520	4 190	9 610*	6 470	9 690*	9 690*	3 970*	2.35	3 970*	2.35
0 m	2 570*	9.22	2 010	9.22	3 320	2 090	4 430	2 820	6 290	3 980	10 000	6 090	8 650*	8 650*	3 870*	1.45	3 750*	1.45
-1.5 m	2 990*	8.69	2 200	8.69			4 360	2 750	6 160	3 860	9 840	5 960	10 810*	10 810*	7 000*	0.27	5 130*	0.27
-3 m	3 900*	7.86	2 580	7.86			4 440	2 830	6 190	3 900	9 870	6 020	14 600*	11 800	9 670*	0.27	7 790*	0.27
-4.5 m	5 100*	6.7	3 380	6.7					6 240	4 130	8 810*	6 230	12 630*	11 910	14 040*	0.93	12 060*	0.93
-6 m	5 280*	4.61	5 280*	4.61											7 590*	3.36	7 590*	3.36

### SH235X-6

SHOE : 600 (mm)G  
BUCKET : SAE/PCSA 1.0 (m<sup>3</sup>)  
ARM LENGTH : 2.40 (m)  
MAXIMUM REACH : 9.37 (m)  
BOOM : 6.15 (m)

Bucket Hook Height	Max. Radius		9 m		7.5 m		6 m		4.5 m		3 m		1.5 m		Min. Radius			
	(kg)	(m)	(kg)	(m)	(kg)	(m)	(kg)	(m)	(kg)	(m)	(kg)	(m)	(kg)	(m)	(kg)	(m)		
9 m	3 760*	5.32	3 760*	5.32					3 510*	3 510*					2 140*	4.14	2 140*	4.14
7.5 m	3 280*	7.08	3 280*	7.08					4 410*	4 410*	3 660*	3 660*			3 560*	4.31	3 560*	4.31
6 m	3 120*	8.12	2 590	8.12			4 470*	3 040	4 950*	4 540	5 170*	5 170*			5 290*	3.95	5 290*	3.95
4.5 m	3 110*	8.72	2 190	8.72			4 660	2 950	5 500*	4 350	6 660*	6 660*	8 410*	8 410*	7 990*	1.74	7 990*	1.74
3 m	3 190*	9	2 010	9	3 200*	2 010	4 520	2 820	6 420*	4 100	8 540*	6 460	10 120*	10 120*	6 310*	2.97	6 310*	2.97
1.5 m	3 250	9	1 960	9			4 380	2 700	6 260	3 860	9 900*	5 950			6 130*	3.16	6 130*	3.16
0 m	3 380	8.72	2 040	8.72			4 280	2 600	6 060	3 680	9 660	5 660	7 700*	7 700*	5 710*	2.57	5 710*	2.57
-1.5 m	3 760	8.16	2 280	8.16			4 260	2 590	6 000	3 630	9 6							



## Principle Specifications

		SH235X-6
		STD Specifications
Base	Std. operating weight	25,000 kg
	Boom length	5.70 m
	Arm length	2.94 m
	Bucket capacity (ISO heaped)	0.80 m <sup>3</sup>
	Shoe width	600 mm
Engine	Counterweight	6,900 kg
	Make & model	ISUZU AM-4HK1X
Hydraulic System	Rated output	119.3 kW/1800 min <sup>-1</sup>
	Piston displacement	5.193 ltr
	Main pump	2 variable displacement axial piston pumps with regulating system
	Max oil flow	2 × 211 ltr/min
	Max pressure	34.3 MPa
	(with auto power boost)	36.8 MPa
	Travel motor	Variable displacement axial piston motor
	Parking brake	Mechanical disc brake
	Swing motor	Fixed displacement axial piston motor
	Travel speed	5.0/3.2 km/h
Performance	Drawbar pull	201 kN
	Grade ability	70% <35° >
	Ground pressure	56 kPa
	Max swing speed	11.8 min <sup>-1</sup>
	Swing torque	64.0 kN·m (6,526 kgf·m)
	Bucket digging force (ISO 6015)	142 kN
	/with power boost	152 kN
	Arm digging force (ISO 6015)	103 kN
	/with power boost	110 kN
	Others	Fuel tank
Hydraulic oil tank		114 ltr

## Standard Equipment

### [Hydraulic system]

- SIH:S+ hydraulic system
- Operation mode (SP, H and A mode)
- Automatic 2-speed travel
- Automatic power boost
- Arm/boom/bucket reactivation circuit
- Automatic swing parking system
- High-performance return filter

### [Cab/interior equipment]

- Roll-over protective structure (ROPS) cab
- Top guard OPG level 1 (in cab structure)
- 4-point fluid mounts
- Built-in type full-colour monitor display
- Open air introducing pressurised full-automatic air conditioner
- Defroster
- KAB seat
- Seat suspension
- Windscreen wiper (with intermittent operation function)
- Cup holder
- AM/FM radio (with muting function and AUX port)
- Radio mute/ Windscreen wiper one-touch control on joystick
- Clock
- Magazine rack
- Accessory case
- Floor mat
- Armrest & headrest
- Ashtray & cigarette lighter
- Cab light (Auto-OFF function)
- Coat hook

### [Safety equipment]

- Rearview mirror (left/right)
- Rearview camera
- Emergency escape tool
- Retracting seat belt
- Gate lock lever
- Travel alarm (with on and off switch)
- Anti-theft alarm system
- Engine room firewall
- Fan guard
- Engine emergency stop switch
- Engine neutral start

### [Others]

- Auto/one-touch idling
- Auto idle shutdown system
- EMS
- Long-life hydraulic oil
- Two lights (main unit and left of boom)
- Fuel filter (with water separator)
- Fuel prefilter (with water separator)
- Double-element air cleaner
- Grease-enclosed track link
- Large tool box
- A set of tools

## Accessories (option)

### ■ Cab-top lights



### ■ Rain deflector



### ■ 12V power (DC-DC converter)



### ■ Air suspension (KAB seat)



### ■ Front mesh guard (full/lower)



### ■ Head guard (OPG level 2)



### ■ Refuel pump

### ■ Hose burst check valve (HBCV) for boom/arm cylinders

### ■ Side camera

## Working Range

SH235X-6		
Arm length	2.40m (SHORT)	2.94m (STD)
Boom length	5.70 m	
A Max digging radius	9,370 mm	9,850 mm
B Max digging depth	6,120 mm	6,650 mm
C Max digging height	10,520 mm	10,860 mm
D Max dumping height	7,630 mm	7,970 mm
E Max vertical wall cut depth	5,480 mm	5,920 mm
F Min front swing radius	2,550 mm	2,310 mm
G Tail swing radius	1,720 mm	

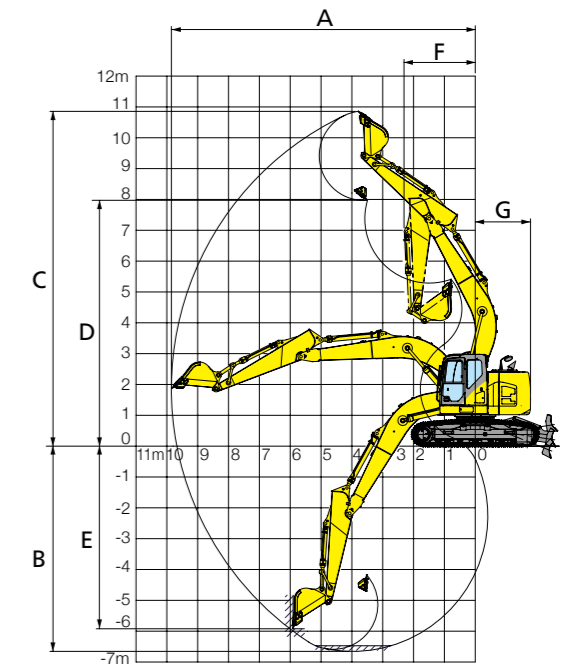

## Dimensions

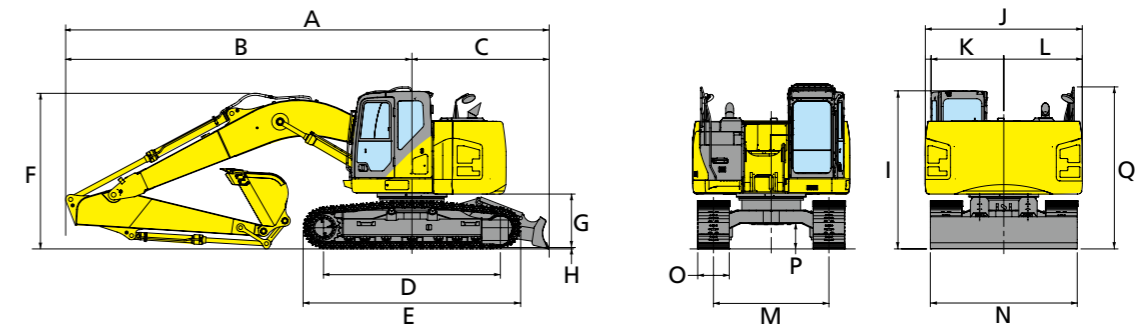

Model	SH235X-6	
Arm length	2.40 m	2.94 m
A Overall length	9 300 mm	9 210 mm
B Length from centre of machine (to arm top)	6 690 mm	6 600 mm
C Upper structure rear end radius	2 610 mm	2 610 mm
D Centre to centre of wheels	3 370 mm	3 370 mm
E Overall track length	4 180 mm	4 180 mm
F Overall height (to top of boom)	3 180 mm	2 960 mm
G Clearance height under upper structure	1 020 mm	1 020 mm
H Shoe lug height	26 mm	26 mm
I Overall height (to top of cab)	3 010 mm	3 010 mm
J Upper structure overall width	2 990 mm	2 990 mm
K Width from centre of machine (left side)	1 390 mm	1 390 mm
L Width from centre of machine (right side)	1 500 mm	1 500 mm
M Track gauge	2 200 mm	2 200 mm
N Overall width	2 800 mm	2 800 mm
O Std. shoe width	600 mm	600 mm
P Minimum ground clearance	440 mm	440 mm
Q Overall height (to top of handrail)	3 090 mm	3 090 mm